

Better Interior



PRODUCT CATALOGUES

WOODEN, WOOD
AND ALUMINIUM
WINDOWS



ENTRANCE
DOORS,
TECHNICAL
DOORS



PRODUCTS WITH
A PRODUCTION TIME
OF UP TO 10 DAYS



CONTENTS

WHAT MAKES US UNIQUE.....	4	FORTIMO LUX.....	102
SYMBOLS AND THEIR MEANINGS.....	5	SONATA LUX.....	104
DIMENSIONS OF INTERIOR DOOR LEAVES.....	6	INTERSOLID.....	106
COLOURS OF INTERIOR DOOR LEAVES.....	7	INTERSOLID II.....	108
METAL/ALUMINIUM DOOR FRAMES COLOUR PALETTE.....	11	PASSO.....	110
COLOURS OAKEN THRESHOLDS.....	11	ESTATO LUX.....	112
ADDITIONAL INFORMATIONS.....	12		
DOOR GLASS.....	12	SLIDING DOOR	
REVES SYSTEM.....	13	SLIDING SYSTEM FOR IN-WALL INSTALLATION.....	114
RECUPERATION SYSTEM.....	14	SLIDING SYSTEM ON-WALL.....	116
HARMONY SYSTEM POL-SKONE CONCEALED		SLIDING SYSTEM ON-WALL PREMIUM.....	118
DOOR LEAF (SLAB).....	15	SLIDING SYSTEM ON-WALL MOVI.....	119
HARMONY SYSTEM POL-SKONE CONCEALED DOOR FRAME.....	16		
FLEXI POL-SKONE SYSTEM FOR HARMONY		SPECIAL DOOR	
CONCEALED DOOR FRAME.....	17	GALIO.....	120
HARMONY INVEST PRO FOR PANEL INSTALLATION.....	18	STALIO.....	122
HARMONY INVEST.....	20	LUMEN.....	124
HARMONY INVEST ULTRA - NEW	22	LUMEN LOFT.....	126
		FOLDING.....	128
		SOUNDPROOF.....	130
INTERIOR DOOR			
PAINTED		DOOR FRAMES	
FIORD.....	24	MDF FIXED.....	132
CAMBIO.....	26	POL-SKONE FIXED.....	133
SIMPLE.....	28	DIN SYSTEM ADJUSTABLE.....	134
SUBITO.....	30	AQUA DIN ADJUSTABLE - NEW	135
SUBLIME.....	32	POL-SKONE SYSTEM ADJUSTABLE.....	136
TIARA.....	34	LUMEN METAL FIXED.....	137
ESTATO.....	36	LUMEN METAL ADJUSTABLE.....	138
PALAZZO.....	38	POL-SKONE SYSTEM METAL DIAGONAL FIXED.....	139
VERTIGO.....	40	POL-SKONE SYSTEM METAL DIAGONAL ADJUSTABLE.....	140
VILANO.....	42	POL-SKONE SYSTEM METAL FIXED.....	141
MODERN.....	44	POL-SKONE SYSTEM METAL ADJUSTABLE.....	142
MODENA.....	46	DUO SYSTEM FIXED.....	143
MODESTO - NEW	48	DIN DUO SYSTEM ADJUSTABLE.....	144
		AQUA DIN DUO ADJUSTABLE - NEW	145
		DUO SYSTEM ADJUSTABLE.....	146
ECO TOP HIGH TOP		VERTIGO ADJUSTABLE.....	147
LOFTY.....	50	POL-SKONE SYSTEM METAL DUO FIXED.....	148
ARCO.....	52	POL-SKONE SYSTEM METAL DUO ADJUSTABLE.....	149
INTER-AMBER.....	54	REVES SYSTEM ADJUSTABLE.....	150
		ADJUSTMENT SYSTEM MADE OF MDF FOR FIXED METAL.....	151
UNI MAT PLUS		TUNNELS / WALL ENCASEMENTS.....	152
SEDO - NEW VERSIONS	56	TOPLIGHTS FOR DIN/DIN DUO DOOR FRAME.....	154
CREATO.....	58	TOPLIGHTS FOR THE FIXED DOOR FRAME.....	155
HAPTIC.....	60	SEMPRE INTERIOR DOOR SIDE PANELS.....	155
		STRIPS.....	156
LAMISTONE SILKSTONE LAMINATED		BASEBOARDS.....	156
ARIA - NEW	62	ABS EDGING.....	156
ESTO - NEW	64	PORTHOLES.....	157
MODO.....	66	CROWNS.....	157
VERI.....	68	VENTILATION OPTIONS.....	158
EGRO.....	70	STAINLESS STEEL PROTECTORS.....	161
FIORI.....	72	ACCESSORIES.....	162
IMPULS.....	74	HANDLES FOR INTERIOR DOORS.....	164
ETIUDA.....	76		
SONATA.....	78		
FORTIMO.....	80		
INVERNO.....	82		
NOSTRE.....	84		
MONA.....	86		
SEMPRE.....	88		
DECO.....	90		
PASSO.....	110		
		ATTENTION!	
VENEERED		WE WILL SOON INTRODUCE NEW PRODUCT CODES (NEW DOOR VERSIONS)	
SEMPRE LUX.....	92	You will already find them next to the icons of the individual door models, e.g.:	
TEO - NEW	94	old code → W02 / V4S4 ← new code	
ESPINA - NEW VERSION	96		
DECO LUX.....	98		
ETIUDA LUX.....	100		

WHAT MAKES US UNIQUE

POL-SKONE FACTORIES



Z1 LUBLIN



Z4 LUBLIN



Z2 NIEMCE



Z3 BIŁGORAJ

VISION

As a Polish family company, we want to be the first choice brand in the premium segment.

MISSION

We are a manufacturer of doors and windows of the highest quality. We are building a strong brand associated with reliability, modern design and technological innovation.

We are a family-owned company, we care about long-term relationships with our business partners, and we treat our employees as our most valuable asset.



FSC® Certificate

Over the last 33 years, POL-SKONE has received many awards and certificates acknowledging the highest quality of services and products.

One of the most important distinctions is the international FSC® (Forest Stewardship Council®)

The FSC® certificate confirms that the raw materials used for the production come only from certified forests, managed in accordance with the law, good environment protection practices, principles of economy and with respect for the locally recognised social values.

SYMBOLS AND THEIR MEANINGS

STRUCTURE

The POL-SKONE door leaves are designed based on various structures and in-fills to be able to fulfil the requirements of various Customers and meet their needs.



Leaf (slab) STRUCTURE
wooden rail and stile
unit, honeycomb-like in-fill



Leaf (slab) STRUCTURE
wooden rail and stile
unit, perforated chipboard in-fill



Leaf (slab) STRUCTURE
wooden rail and stile
unit, solid chipboard in-fill



Leaf (slab) STRUCTURE
glued laminated wood



Leaf (slab) STRUCTURE
high quality MDF board



Leaf (slab) STRUCTURE
special POL-SKONE structure

DIMENSIONS

For the standard dimensions of interior leaves, go to page 6 (some models are additionally available in non-standard dimensions). For information on dimension ranges and door frames for relevant door models, go to the pages containing their respective descriptions.

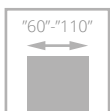

"60"- "110"
SINGLE LEAF (SLAB) DOORS
(range of dimensions)

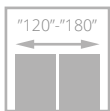

"120"- "180"
DOUBLE LEAF (SLAB) DOORS
(range of dimensions)

IN-FILL



"honeycomb"



perforated chipboard



solid chipboard

ATTRIBUTES



NEW
NEW
new products
in the POL-SKONE line



FAST DELIVERY
door production takes
10 working days + delivery
to customer



BESTSELLER
most popular door models



CHOICE OF DEVELOPERS
products recommended
by experts

SYSTEMS

The configuration in which the door frame is connected to the leaf (slab) includes the rebated system and the non-rebated system. The former has a rabbet (groove) which overlaps the door frame; in the latter one, the leaf (slab) edge and the door frame form a uniform plane. The unique Harmony system uses a door frame concealed in the wall. POL-SKONE also offers a sliding system door.



REBATED SYSTEM
the leaf (slab) has a rabbet (groove) which overlaps the door frame



NON-REBATED SYSTEM
the straight leaf (slab) edge and the door frame form a uniform plane



REVES SYSTEM
the leaf (slab) has a reverse groove (notch) which is coplanar with the frame



HARMONY SYSTEM
a system with a door frame concealed in the wall

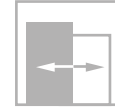

SLIDING SYSTEM
available for the sliding system

SPECIFICATIONS

POL-SKONE offers doors with special technical properties.



soundproof doors



flame retardant door



anti-burglar doors



mechanical class
I, II, III or IV

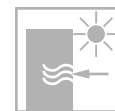

thermal transmittance



smoke control doors



resistance to climatic conditions



RTG

DIMENSIONS OF INTERIOR DOOR LEAVES

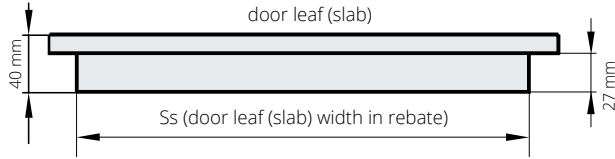

the POL-SKONE rebated door leaves fit all door frames which comply with the Polish industry standards

width (Ss)					height in rebate
618	718	818	918	928*	(mm)
					2020 (mm)

*width "90 plus"

Full range of dimensions of interior doors with door frames - p. 132-151

HANDLE HEIGHT

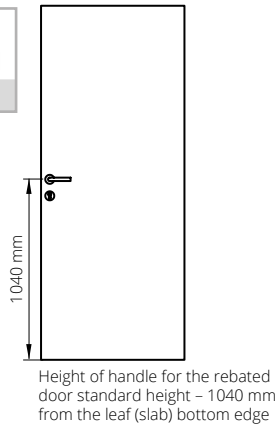

SYMMETRY IS PARAMOUNT
STANDARDISED
HANDLE HEIGHT IN
REBATED AND NON-
REBATED SYSTEM

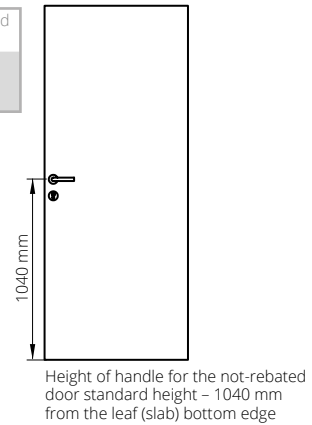

Single leaf (slab) rebated doors - opening directions

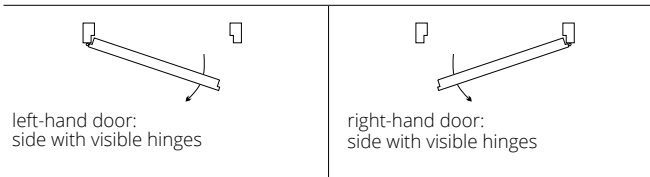

Double leaf (slab) rebated doors - opening directions

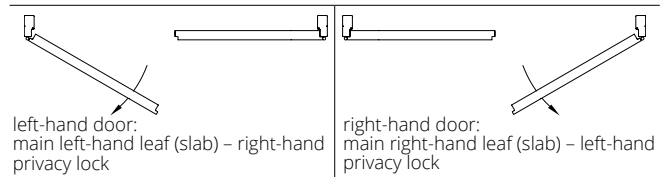

DUO non-rebated door - opening directions

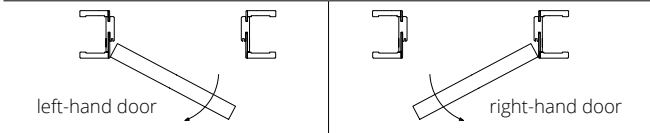

REVES door - opening directions

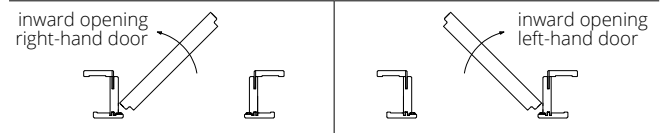

HARMONY door - opening directions

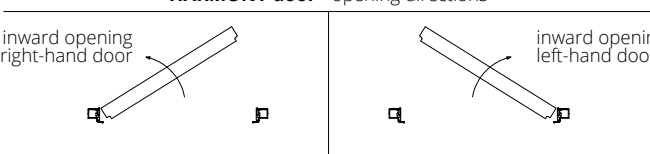

HARMONY door - opening directions

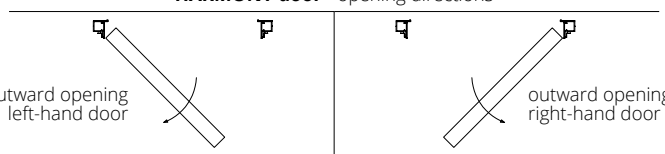

CLEARANCE BETWEEN LEAF (SLAB) AND FLOOR

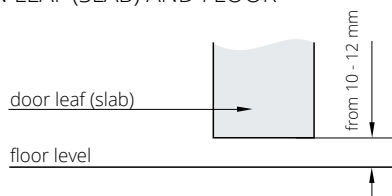

version with Swiss threshold (option)

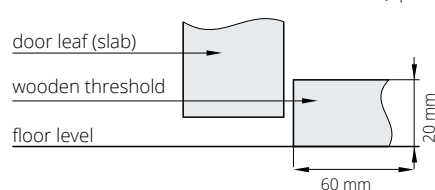

Dimensions of interiors entrance doors and exterior doors are provided on pages dedicated to the particular models of these doors.

COLOURS OF INTERIOR DOOR LEAVES

ECO TOP

A surface that provides the perfect combination of price and quality for long term household use.

HIGH TOP

ECO TOP surface finish with additional real wood grain effect.

UNI MAT PLUS

Reinforced surface with silky tactile experience and special fingerprint-proof coating.

LAMISTONE CPL

Surface finish with protective coating for resistance to wear and chemicals. Recommended for public utility buildings and applicable to intensive door use conditions, e.g. in hotels and offices.

SILKSTONE

LAMISTONE CPL surface finish with additional unique real wood grain effect.

SILKSTONE CPL 0,5 mm

Surface finish featuring the properties and resistance of the CPL 0.5 laminate with additional unique real wood grain effect. Recommended for public utility buildings and applicable to intensive door use conditions, e.g. in hotels and offices.

LAMINATED

Highly resistant surface finish recommended for public utility buildings and applicable to intensive door use conditions, e.g. in hotels and offices. Differences in colour shades of door leaves, door frames and spacer frames are acceptable.

VENEERED

The POL-SKONE veneered doors are coated with environment-friendly UV varnish. It is certainly more resistant to scratches and light than standard varnishes, including those laid in multiple layers. The actual colour shades and wood grain of veneers may vary since natural veneers are used.

PAINTED

Environment-friendly acrylic paints, RAL and NCS colours* (except the metallic ones) – available at an extra charge according to the colour specification table for particular models.

ECO TOP

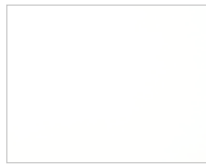

120 white



121 oak



132 walnut



141 Salinas oak



158 honey oak



160 sonoma oak



161 half oak

HIGH TOP



148 coffee ash

UNI MAT PLUS



640 graphite



641 titano

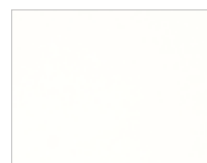

642 white

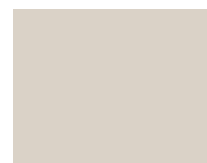

643 beige



644 black



645 lava



646 stone



647 indigo



648 moss



649 sage

* available upon consultation with the Sales Department

The actual colours may vary from the colours printed in the catalogue. Differences in colour shades of door leaves, door frames and spacer frames are acceptable.

**LAMISTONE
CPL**



231 half oak



240 whitewashed elm V



241 sand elm V



242 grey elm V



243 delano oak



244 black



250 terra oak

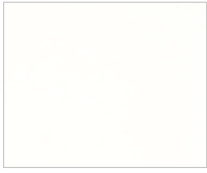

258 white



260 white oak



263 premium walnut



265 wenge



289 grey



531 anthracite



232 segato walnut

SILKSTONE



230 gran oak



254 Royal anthracite H



255 Polish ash H



276 Polish oak



293 Royal anthracite



294 Royal ash



295 Royal merbau



296 Polish ash



297 Royal nougat



299 Royal ash H

**SILKSTONE
CPL 0,5 mm***



976 Polish oak



993 Royal anthracite



994 Royal ash



995 Royal merbau



996 Polish ash



997 Royal nougat

* available upon consultation with the Sales Department

**LAMINATED
CPL 0,2 mm**

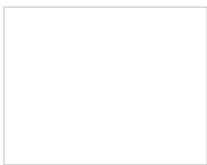

820 white

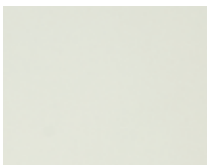

222 grey



225 terra oak



227 delano oak



229 oak



280 halif oak

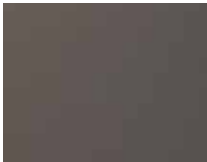

821 anthracite



844 black



849 industry 3**



863 premium walnut



228 segato walnut

**LAMINATED
CPL 0,5 mm***

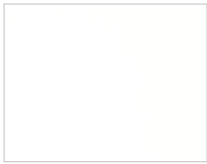

945 white structure



252 oak



922 grey structure



926 anthracite structure



965 wenge



963 premium walnut



946 black structure



961 halif oak

**LAMINATED
CPL 0,7 mm***

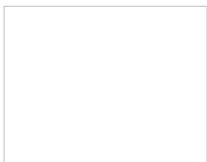

745 white structure



722 grey structure



779 oak



726 anthracite structure



765 wenge



763 premium walnut



746 black structure



761 halif oak

**LAMINATED
HPL***

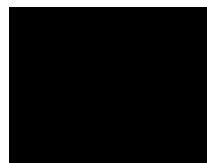

HPL colours apply to:
HARMONY INVEST,
DECO, FOLDING DOOR,
SOUNDPROOF DOOR, CERBER
PLUS, CERBER PLUS RC2, B-30,
C-30, RC3, RC3 INVEST, RC4,
RC4EI30.

* available upon consultation with the Sales Department.

** colours available while stocks last

The actual colours may vary from the colours printed in the catalogue. Differences in colour shades of door leaves, door frames and spacer frames are acceptable.

**VENEERED
GROUP A**



311 bright oak*



312 swiss pine*



334 European oak

**VENEERED
GROUP B**



323 rustic oak



340 ebony



351 marrone



376 steel oak



390 natural walnut



404 dark walnut



405 bright walnut



421 cappuccino



422 mocca



424 teak

**VENEERED
GROUP C**



370 white-stained oak



450 white matt



451 black matt



452 grey matt

**VENEERED
GROUP D**



460 makassar

PAINTED

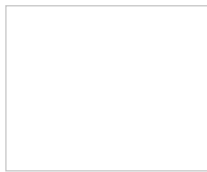

001 white (RAL 9003)

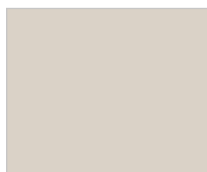

0M6 beige matt
(NCS s2005 Y50R)

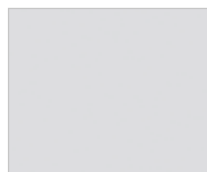

0M5 grey matt
(RAL 7047)



RAL and NCS colours**

BLACK

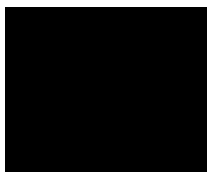

002 black (RAL 9005)



003 sage
(NCSs4010-G50Y)

*available upon consultation with the Sales Department

**NCS colours – upon consultation with the Sales Department

Colour samples and colour charts available on the market should be treated as illustrative. They may differ slightly from the final colour and shall not constitute grounds for complaint. Unless the colour/painting has been approved in advance in consultation with the manufacturer. In order to verify the actual colour, a test painting must be ordered.

RAL PALETTE – division of colours according to the colour intensity grade (not applicable to the metal door frame). RALcolour palette for metal door frames – p. 11

GROUP I extra charge acc. to the extra charge table

6020 7002 7042 8000 9002

GROUP II extra charge acc. to the extra charge table

1000 1001 1002 1012 1013 1014 1015 1020 3011 3016 4002 4006 5001 5002 5005 5007 5008 5009 5010 5012 5013 5015 5017 5019 5022 5024 6000 6001 6004 6005 6007 6009 6012 6013 6014 6015 6016 6021 6022 6024 6026 6028 6029 6032 6034 7000 7001 7003 7004 7005 7006 7008 7009 7010 7011 7012 7013 7015 7016 7021 7022 7023 7024 7026 7030 7031 7032 7033 7034 7035 7036 7037 7038 7039 7040 7043 7044 7045 7046 7047 8001 8003 8007 8008 8011 8014 8015 8016 8017 8019 8022 8023 8025 8027 8028 9001 9010 9016 9018

GROUP III extra charge acc. to the extra charge table

1011 1021 1027 1037 2011 3009 3012 3013 3014 3015 4010 5003 5004 5011 5014 5018 5021 6002 6006 6008 6010 6017 6018 6025 6027 6033 8002 8004 8012

GROUP IV extra charge acc. to the extra charge table

1007 1016 1018 1032 2000 2004 3000 3002 3017 3018 3027 4001 4004 4005 4007 4008 4009 5000 5023 6023 6011 6019 6031 8024

GROUP V extra charge acc. to the extra charge table

1003 1004 1005 1006 1017 1019 1023 1024 1028 1033 1034 2001 2002 2003 2008 2009 2010 2012 3001 3020 3028 3031 6037

METAL/ALUMINIUM DOOR FRAMES COLOUR PALETTE

Standard colours available in standard surface finish SEMI-MATT

STANDARD COLOURS



RAL COLOUR SURCHARGE TABLE
FOR DOOR METAL FRAMES
no possibility to make door frames in NCS colors

Colour group
GROUP I
GROUP II
GROUP III
GROUP IV
GROUP V

STRUCTURE COLOURS



SURCHARGE TABLE - STRUCTURES
Extra charge to the basic price of the metal frame

rebated system
non-rebated system
HARMONY in colour RAL 9003, RAL 9005



The range of entrance and exterior doors and technical doors is available in separate publications.

RAL COLOUR PALETTE (applies to metal and aluminium door frames)

GROUP I																																				
1000	1002	1011	1013	1015	1019	1020	3009	4001	5000	5001	5004	5005	5007	5008	5009	5010	5011	5013	5014	5017	5019	5020	5021	5022	5023	5024	6000	6003	6004							
6005	6006	6007	6008	6011	6012	6013	6014	6015	6019	6020	6026	6027	6033	6034	7000	7001	7002	7003	7004	7005	7006	7008	7009	7010	7011	7012	7013	7015	7016							
7021	7022	7023	7026	7030	7031	7032	7033	7034	7035	7036	7037	7038	7039	7040	7042	7043	7044	7045	7046	8000	8001	8002	8003	8004	8007	8011	8012	8015	8017							
8019	8022	8023	8025	8028	9001	9002	9010	1024HR	6021HR	9004HR	9005HR																									
GROUP II																																				
1014	3000	3001	3002	3004	3007	3011	3013	3016	4002	4008	5002	5003	5012	5015	5018	6017	6022	6025	6029	9018	3031HR	4005HR	4006HR	6002HR	8008HR											
GROUP III																																				
3003	3005	3020	3022	6010	6018	6024	1024HR	4004HR	4010HR	6032HR																										
GROUP IV																																				
3012	3014	6001	6028	3027HR	4003HR	4007HR	6037HR																													
GROUP V																																				
1003	1004	1005	1006	1016	1017	1018	1021	1023	1027	1032	1033	1034	1037	2000	2001	2002	2004	2009	2010	2011	2012	3018	9006	1027HR	1028HR	2003HR	2008HR	3028HR								

The RAL colouring of metal frames and aluminium frames differs from the RAL colouring of painted door leaves due to the different material application technology.

COLOURS OAKEN THRESHOLDS

applicable to models CERBER PLUS, CERBER PLUS RC2, B-30, C-30, RC3 and RC4



varnished oaken threshold, silver-coloured ALU strip (standard)



varnished grey-coloured oaken threshold, silver-coloured ALU strip (optional)



varnished brown-coloured oaken threshold, black-coloured ALU strip (optional)



varnished black-coloured oaken threshold, black-coloured ALU strip (optional)

ADDITIONAL INFORMATIONS

CONNECTION OF STRIPS

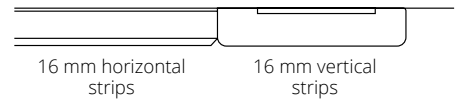
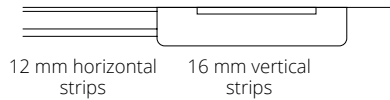
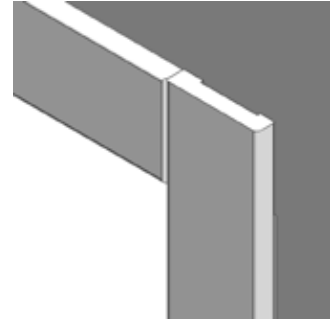
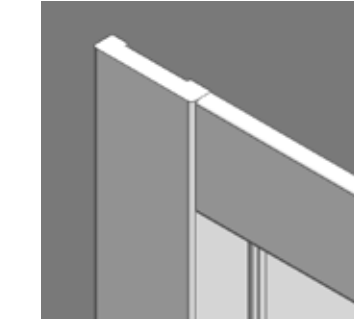
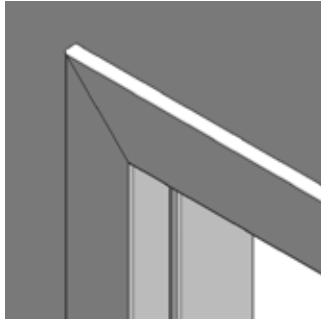

A, B VERSION

B 90° VERSION

C 90° VERSION

architraves interconnected at the 45° angle,
width: 60 mm
architraves interconnected at the 45° angle,
width: 80 mm

architraves interconnected at the 90° angle,
width: 80 mm (applicable to DIN B version,
DUO and DIN DUO door frame)

architraves interconnected at the 90° angle,
width: 80 mm (applicable to DIN B version
and DIN DUO door frame)

DOOR GLASS

See which side is the matt side of the glass

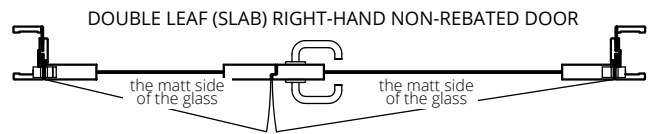
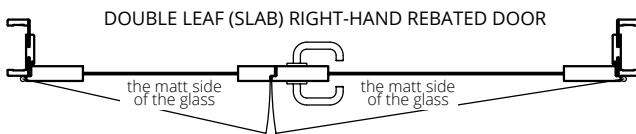
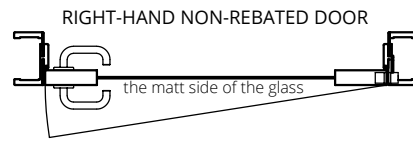
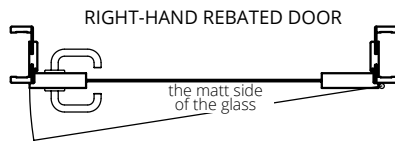

SLIDING SYSTEM FOR IN-WALL INSTALLATION

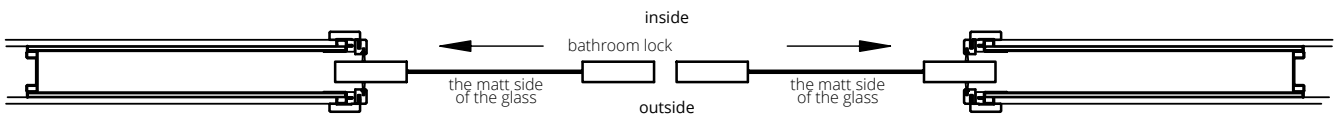

SLIDING SYSTEM FOR IN-WALL INSTALLATION

left-hand door

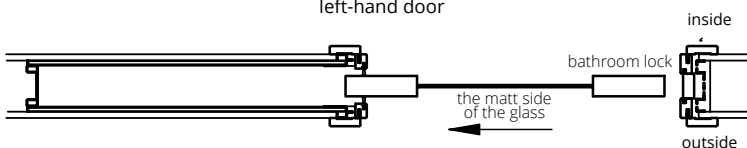

ON-WALL SYSTEM

left-hand door





REVES SYSTEM

Door made of a **wooden rail and stile set** topped with two HDF boards. The standard in-fill is a honeycomb-like layer. Perforated chipboard in-fill and solid chipboard in-fill available at an extra charge. REVES leaf (slab) available as glazing models: IMPULS W13, IMPULS W14, ESTADO A01, ESTADO A02, ESTADO A03, ESPINA W01, CREATO A01, CREATO A02, CREATO A03, ESTADO LUX A01, ESTADO LUX A02, ESTADO LUX A03. REVES leaf (slab) available as flush models (without glazings): CAMBIO, SIMPLE, SUBLIME, TIARA, VERTIGO, VILANO, MODERN, MODENA, LOFTY, INTER AMBER, HAPTIC, IMPULS, SONATA, INVERNO, NOSTRE, DECO, ESPINA, DECO LUX, SONATA LUX, ESTADO, CREATO, ESTADO LUX, PALAZZO.

The combination of the DUO and REVES systems gives new interior arrangement opportunities. It enables the door opening in various directions to have an identical appearance when seen from the corridor side. The plane surface in both systems is flush with the door frame surface, forming a single plane with it. The hinges remain concealed and therefore the difference in their structure will not be visible from the corridor side.

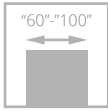

leaf (slab) in the REVES system (left side), right-hand - opened inwards; leaf (slab) in the DUO system (right side), left-hand - opened outwards



DUO concealed hinge, silver colour - DUO system



TE concealed hinge, silver colour - REVES system

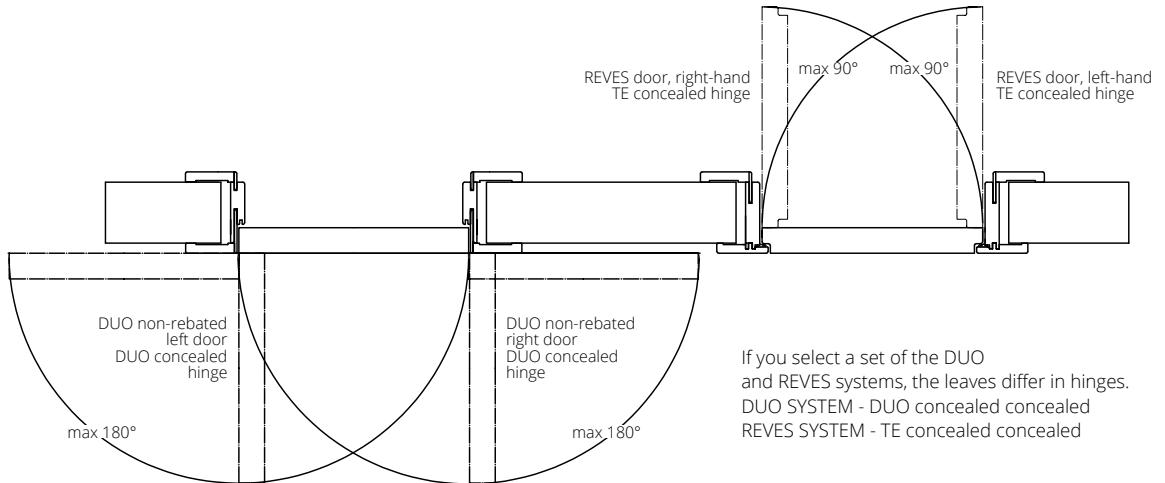

leaf (slab) in the REVES system (left side), right-hand - opened inwards; leaf (slab) in the DUO system (right side), left-hand - opened outwards

model REVES door frame p. 150

EQUIPMENT

STANDARD

magnetic mortise lock, key-operated (spacing: 90 mm), for a cylinder (spacing: 85 mm) or a bathroom lock (spacing: 90 mm)
concealed: concealed TE satin chrome ("60"-80" - 2 pcs, "90"-100" - 3 pcs)
architraves interconnected at the 45° angle only
electric action door strike is not available
ABS edging is not available

ADDITIONAL (available at an extra charge)

perforated chipboard in-fill
solid chipboard in-fill (third hinge recommended)

drop seal

third hinge in the door leaf (slab):
concealed TE for a width of "60"-80"
standard chrom satin coloured lock replaced with white or black colour
standard silver-coloured lock replaced with black-coloured or polished golden-coloured one
door higher by 50 mm or 100 mm (third hinge recommended)
door higher by 200 mm (third hinge recommended) Cambio 00, Lofty, Inter Amber A00, Haptic 00, Impuls W01, Deco 00, Deco Lux 00
door lower by 55 mm or 100 mm

maximum height of door with the REVES frame - 2288 mm

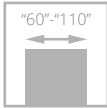

INTERIOR DOOR FOR ROOMS WITH A RECUPERATION SYSTEM



recuperation trim

The following models include doors with a recuperation trim: CAMBIO, SIMPLE, TIARA, INTER-AMBER, IMPULS, SONATA, INVERNO, NOSTRE, DECO, DECO LUX, HARMONY, SUBLIME, VILANO, VERTIGO, FIORD, MODERN, MODENA, HAPTIC. Recuperation trim for doors: ARCO, SEDO, MODO, VERI, EGRO, FIORI, FORTIMO, MONA, SEMPRE, SEMPRE LUX, FORTIMO LUX (Applicable to the standard height) at extra charge

The door leaves are 15 mm shorter than the standard height, i.e. 2005 mm (rebated system) and 2025 mm (non-rebated system and HARMONY opened inwards), 2035 mm (HARMONY opened outwards); the door frame height remains standard.

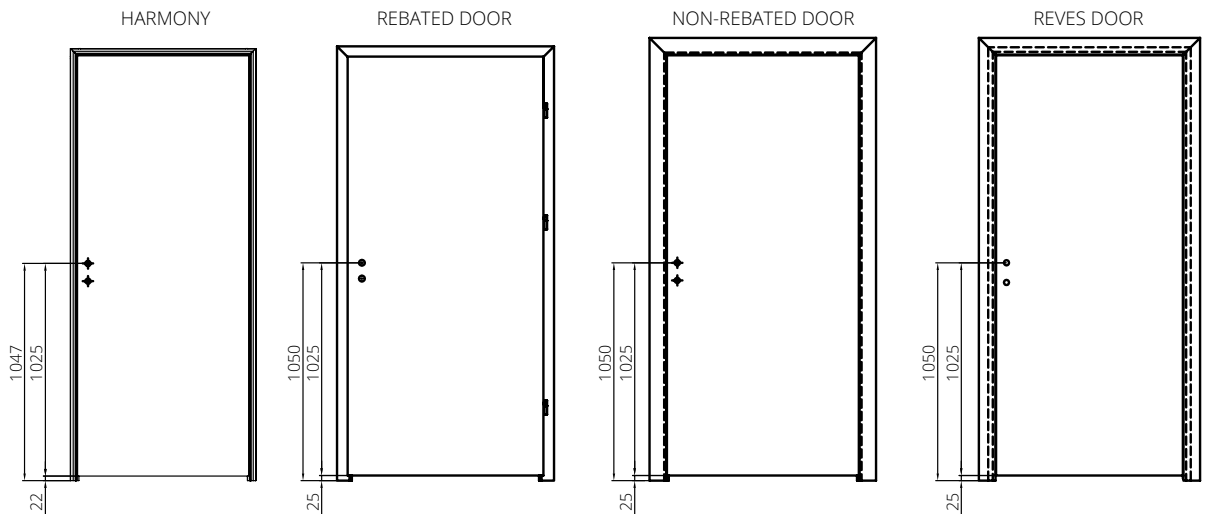

The door compatible with a recuperation system is available at a standard door price. In the www.drzwionline.pl configurator, the RECUPERATION TRIM option can be selected only when the standard height leaf (slab) and door frame are selected as a complete set.



recuperation trim in CAMBIO door, version 00, SYSTEM DIN adjustable frame



HARMONY SYSTEM POL-SKONE CONCEALED door leaf (slab)

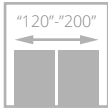
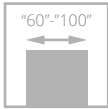

THE BEST OFFER ON THE MARKET

HARMONY IDEA* leaf (slab) for self-painting + ALU door frame raw for self-painting (applies to door leaf (slab) width "60"-90" cm x height 2040/2050 mm honeycomb filling)



***single leaf (slab) door with hidden frame HARMONY with solid chipboard in-fill, equipped with a dropping seal, has the following parameters sound insulation power $R_w=27$ dB**

SPECIFICATIONS

Mechanical resistance requirements class 2, i.e. average service conditions

Leaf (slab) STRUCTURE

Non-rebated system leaf (slab) (opened outwards) or with a notch (opened inwards). The door leaf (slab) structure consists of a **rail and stile set** made of **coniferous wood**, topped with HDF boards on both sides. The leaf (slab) in-fill consists of a "honeycomb" type cellular cardboard, perforated or solid chipboard. The rated thickness of the door leaf (slab) is 40 mm.

The door leaf (slab) is designed in such a way that it can be installed flush with the door frame surface.

DOOR Leaf (slab) FINISH

HARMONY IDEA smooth surface, prime-coated for DIY painting, laminated, painted or veneered.

ACCESSORIES

Standard equipment:
concealed hinge (adjustable in 3 planes)
key-operated, cylinder or bathroom type magnetic lock
door opened inwards - ABS edging is not available

Auxiliary equipment (available at an extra charge):
perforated chipboard in-fill
solid chipboard in-fill
drop seal
additional hinge in the door leaf (slab)
ventilation trim (p. 159)
HOBES 2784 roller lock
preparation for an additional hinge (extra charge to the door leaf (slab))
for other door dimensions - contact the Sales Department

recuperation trim
Adapting the leaf (slab) for mounting a mirror or tile 4 mm thick on one side (full plate and additional hinge required. Number of hinges "60-80" - 3 pcs, "90-100" - 4 pcs. It is recommended to install the handle on the split shaft).
Maximum height of door - leaf (slab) adapted to mirror is 2240/2250 mm.

HARMONY door leaf (slab) trimmed every 10 mm is available

Double leaf (slab) door with an asymmetric division line is available on request

WIDTH

single leaf (slab) door				double leaf (slab) door				
type	S_d^*	S_d^{**}	S_o	type	S_d^*	S_o^*	S_d^{**}	S_o^{**}
"60"	696	693	710	"60"+"60"	1315	1330	1309	1325
"70"	796	793	810	"70"+"70"	1515	1530	1509	1525
"80"	896	893	910	"80"+"80"	1715	1730	1709	1725
"90"	996	993	1010	"90"+"90"	1915	1930	1909	1925
"100"	1096	1093	1110	"100"+"100"	2115	2130	2109	2125

HEIGHT

	H_d	H_o
	2092*	2100*
	2082**	2090**

* door openable inwards ** door openable outwards

S_d - door frame external width

H_d - door frame external height

S_o - installation hole width

H_o - installation hole height

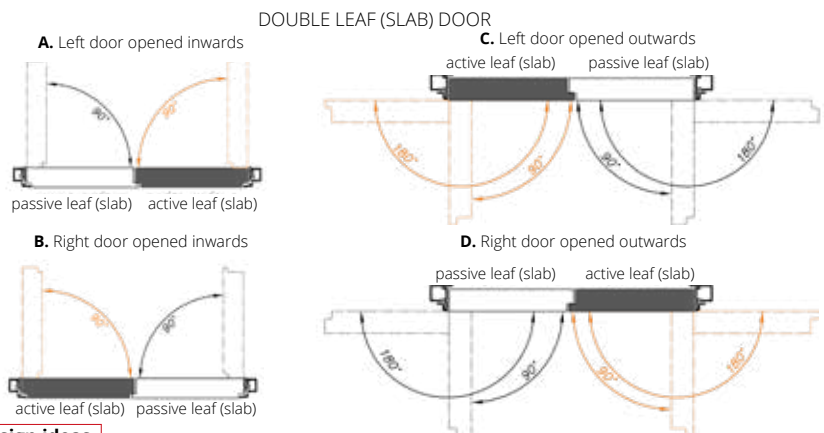
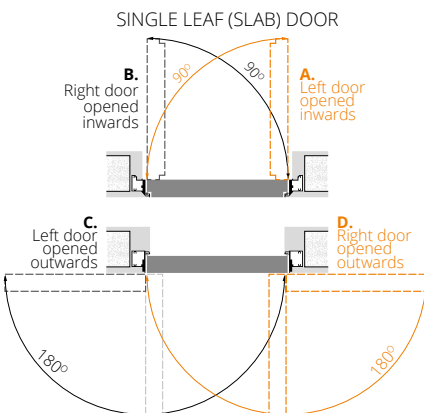

DOOR LEAF (SLAB) FOR THE HARMONY DOOR FRAME

HARMONY IDEA - open to your design ideas

leaf (slab) dimensions

HARMONY IDEA

raw door leaf (slab) prepared for do-it-yourself painting

LAMISTONE
SILKSTONE
UNI MAT PLUS

PAINTED white
white hinges

PAINTED grey, beige
white hinges

BLACK black, sage
black hinges

VENEERED

GROUP A GROUP B GROUP C

"60" - "90" x 2040/2050 mm
"100" x 2040/2050 mm
"60" - "90" x 2140/2150 mm
"100" x 2140/2150 mm
"60" - "90" x 2240/2250 mm
"100" x 2240/2250 mm
"60" - "90" x 2340/2350 mm
"100" x 2340/2350 mm
"60" - "90" x 2440/2450 mm

HARMONY SYSTEM POL-SKONE

CONCEALED door frame



PATENTED COMBINATION



DOOR FRAME - COLOURS

Concealed door frame for inwards or outwards opened doors. Made from anodised aluminum, raw aluminium for do-it-yourself painting in the colour of the wall or painted in white (RAL 9003), black (RAL 9005).

ACCESSORIES

Standard equipment:

concealed hinge (adjustable in 3 planes) - satin chrome colour - quantity of hinges as per table

key-operated, cylinder or bathroom type magnetic lock

Auxiliary equipment (available at an extra charge):

door frames in metallic colours (p. 11)

concealed hinge for the Harmony door frame in the colour of white, black or silver

door frame adaptation to the HOBES 2784 roller lock

door frame available with averse or reverse action electric strike - contact with the Sales Department

HARMONY door frame trimmed every 10 mm is available

HARMONY DOOR FRAME FOR SINGLE LEAF (SLAB) DOOR

door leaf (slab) dimensions and the number of hinges	for do-it-yourself painting (raw aluminum)	anodized aluminum	PAINTED white, beige, grey white hinges
			BLACK black, sage black hinges
"60"- "80" x 2040/2050 mm (2 concealed hinges)			
"90"- "100" x 2040/2050 mm (3 concealed hinges)			
"60"- "100" x 2140/2150 mm (3 concealed hinges)			
"60"- "100" x 2240/2250 mm (3 concealed hinges)			
"60"- "100" x 2340/2350 mm (4 concealed hinges)			
"60"- "100" x 2440/2450 mm (4 concealed hinges)			

HARMONY DOOR FRAME FOR DOUBLE LEAF (SLAB) DOOR

door leaf (slab) dimensions and the number of hinges	for do-it-yourself painting (raw aluminum)	anodized aluminum	PAINTED white, beige, grey white hinges
			BLACK black, sage black hinges
"60"+ "60", "70"+ "70", "80"+ "80" x 2040/2050 mm (4 concealed hinges)			
"90"+ "90", "100"+ "100" x 2040/2050 mm (6 concealed hinges)			
"60"+ "60", "70"+ "70", "80"+ "80", "90"+ "90", "100"+ "100" x 2140/2150 mm (6 concealed hinges)			
"60"+ "60", "70"+ "70", "80"+ "80", "90"+ "90", "100"+ "100" x 2240/2250 mm (6 concealed hinges)			
"60"+ "60", "70"+ "70", "80"+ "80", "90"+ "90", "100"+ "100" x 2340/2350 mm (8 concealed hinges)			
"60"+ "60", "70"+ "70", "80"+ "80", "90"+ "90", "100"+ "100" x 2440/2450 mm (8 concealed hinges)			

FLEXI POL-SKONE SYSTEM FOR HARMONY CONCEALED DOOR FRAME

PATENTED DESIGN



ADJUSTMENT SYSTEM MADE OF MDF



ECO TOP	PAINTED** white	PAINTED** grey, beige	BLACK black, sage	UNI MAT PLUS LAMISTONE SILKSTONE	veneered	
				GROUP A (311, 312, 334)	GROUP B (323, 370, 372, 376, 390, 404, 405, 421, 422, 424)	

HW, range in mm 85-310

HZ, range in mm 95-320

* the adjustment range includes the thickness of the HARMONY door frame
 ** RAL 9003, architraves 80 mm wide

COMPLETION OF COMPONENTS

	adjustment range	HARMONY CONCEALED door frame	adjustment range	HARMONY CONCEALED door frame	adjustable angular architrave	panel
HW1	85-90		HZ1	95-100	12 mm	46 mm
HW2	90-95		HZ2	100-105	12 mm	51 mm
HW3	95-105		HZ3	105-115	16 mm	56 mm
HW4	105-130		HZ4	115-140	32 mm	66 mm
HW5	130-150		HZ5	140-160	32 mm	91 mm
HW6	150-170	opened inwards HARMONY CONCEALED door frame	HZ6	160-180	opened outwards HARMONY CONCEALED door frame	32 mm 111 mm
HW7	170-190		HZ7	180-200		32 mm 131 mm
HW8	190-210		HZ8	200-220	32 mm	151 mm
HW9	210-230		HZ9	220-240	32 mm	171 mm
HW10	230-250		HZ10	240-260	32 mm	191 mm
HW11	250-270		HZ11	260-280	32 mm	211 mm
HW12	270-290		HZ12	280-300	32 mm	231 mm
HW13	290-310		HZ13	300-320	32 mm	251 mm

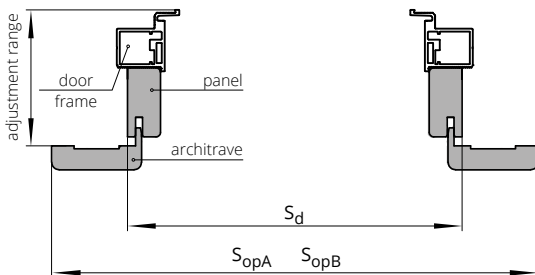

		opened inwards					opened outwards					
installation dimension	Sd	SopA	SopB	Hd	HopA	HopB	Sd	SopA	SopB	Hd	HopA	HopB
"60"	683	783	823				663	763	803			
"70"	783	883	923				763	863	903			
"80"	883	983	1023	2086	2136	2156	863	963	1003	2067	2117	2137
"90"	983	1083	1123				963	1063	1103			
"100"	1083	1183	1223				1063	1163	1203			

Maximum external height Hd 2286 mm
 Maximum external height Hd 2267 mm

Sd - installation external width
 SopA - architrave (60 mm) external width
 SopB - architrave (80 mm) external width
 Hd - installation external height
 HopA - architrave (60 mm) external height
 HopB - architrave (80 mm) external height

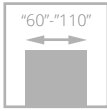

acoustic
insulation
Rw = 37dB

HARMONY INVEST PRO FOR PANEL INSTALLATION

- **solid construction** – wooden rail and stile set reinforced with steel bars
- **aluminium frame**, reinforced, allowing to create a single surface of the wall panel with 4 mm thick door leaf (slab)
- **abundant colours** with the ECO TOP, LAMINATED CPL, LAMISTONE CPL, SILKSTONE, UNI MAT PLUS, VENEERED and PAINTED surface finish
- door leaf (slab) equipped with a **drop down seal**
- **Rw = 37dB acoustic insulation**
- rated **leaf (slab) thickness: 50 mm**

Entrance internal doors intended for rooms in public buildings including offices, hotels, etc.

door width opened outwards ODZP "60" - "90"

4 mechanical class according to PN-EN 1192:2001

door width opened outwards ODZP "90 plus" - "110"

3 mechanical class according to PN-EN 1192:2001

door width opened inwards ODWP "60" - "110"

3 mechanical class according to PN-EN 1192:2001

acoustic insulation: **Rw= 37 dB, D₁-35, D₂-30**

HARMONY INVEST PRO door, with HARMONY INVEST aluminium door frame and panel installation



HARMONY INVEST PRO door with HARMONY INVEST aluminium door frame



HARMONY INVEST PRO DOOR Leaf (slab) AND PANEL

colours

raw for do-it-yourself painting

ECO TOP

LAMISTONE CPL

UNI MAT PLUS

SILKSTONE

SILKSTONE CPL 0,5 mm

LAMINATED CPL 0,2 mm

PAINTED white, beige, grey

BLACK RAL 9005, sage

VENEERED GROUP A

VENEERED GROUP B

VENEERED GROUP C

SILKWOOD

panels – price per 1 m² (the exact dimensions of the panels are available upon consultation with the Sales Department)

ATTENTION! For panel heights of 2200 to 2500 mm, visible micro-glueing of the veneer.

VERSION

W00 / V00

COLOURS



*available at an extra charge upon consultation with the Sales Department

DOOR FRAMES

HARMONY INVEST PRO DOOR FRAME FOR PANEL

leaf (slab) dimensions [mm]	raw for do-it-yourself painting	ODW			raw for do-it-yourself painting	ODZ		
		PAINTED white	PAINTED grey, beige	BLACK black, sage		PAINTED white	PAINTED grey, beige	BLACK black, sage
625-960 x 2040/2050								
1025-1125 x 2040/2050								
625-960x 2140/2150								
1025x1125 x 2140/2150								
625-960 x 2240/2250								
1025x1125x2240/2250								
625-960 x 2340 /2350								
1025-1125 x2340/2350								
625-960 x 2440/2450								
1025-1125x 2440/2450								

surcharge for structural colors

HARMONY INVEST PRO DOOR opened inwards for panel installation

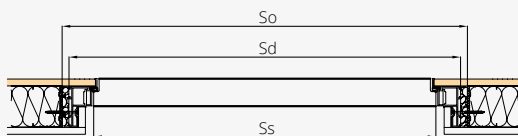

HARMONY INVEST PRO DOOR opened outwards for panel installation

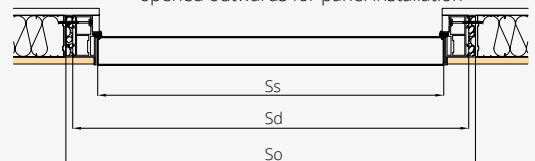

DOOR OPENABLE INWARDS ODW

	WIDTH [MM]			HEIGHT [MM]		
	Ss	Sd	So	Hs	Hd	Ho
"60"	625	715	735	1950	2002	2015
"70"	725	815	835	2050 - standard	2102	2115
"80"	825	915	935	2150	2202	2215
"90"	925	1015	1035	2250	2302	2315
"90 plus" *	960	1050	1070	2350	2402	2415
"100"	1025	1115	1135	2450	2502	2515
"110"	1125	1215	1235			

DOOR OPENABLE OUTWARDS ODZ

	WIDTH [MM]			HEIGHT [MM]		
	Ss	Sd	So	Hs	Hd	Ho
"60"	625	715	735	1940	1992	2005
"70"	725	815	835	2040 - standard	2092	2105
"80"	825	915	935	2140	2192	2205
"90"	925	1015	1035	2240	2292	2305
"90 plus" *	960	1050	1070	2340	2392	2405
"100"	1025	1115	1135	2440	2492	2505
"110"	1125	1215	1235			

* investment width

So - installation hole width
Ss - door leaf (slab) width
Sd - door frame external width

Ho - installation hole height
Hs - door leaf (slab) height
Hd - door frame external height

EQUIPMENT

STANDARD

magnetic mortise lock, key-operated (spacing: 90 mm), for a cylinder (spacing: 85 mm) or a bathroom lock (spacing: 90 mm)
opened outwards: SIMONSWERK TECTUS TE 541 3D FVZ type concealed hinges, 3D adjustable ("60"- "90" - 2 pcs, "100"- "110" - 3 pcs)
opened inwards: SIMONSWERK TECTUS TE 240 3D type concealed hinges, 3D adjustable ("60"- "110" - 3 pcs)
door higher than standard - 3 pcs
drop down seal
recuperation trim*

ADDITIONAL (available at an extra charge)

CPL laminate 0.5 mm ("60" - "90")
CPL laminate 0.7 mm ("60" - "90")
CPL laminate 0.5 mm ("90+" - "110")

CPL laminate 0.7 mm ("90+" - "110")

SILKSTONE CPL colours

"100" width

"110" width

ventilation trim*

mortise sash lock

higher door - 2150/2140

higher door - 2250/2240

higher door - 2350/2340

higher door - 2450/2440

matching wall panel grain to the door as per pattern (tolerance of up to 10 mm)

*doors with ventilation trim or undercut do not have a drop seal and the declared acoustic and air permeability parameters. matching wall panel grain to the door as per pattern (tolerance of up to 10 mm)

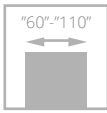

HARMONY INVEST door, HARMONY INVEST aluminium door frame

HARMONY INVEST

- **solid construction - wooden rail and stile** set reinforced with steel bars
- **abundant colours** with the ECO TOP, LAMINATED CPL, LAMISTONE CPL, SILKSTONE, UNI MAT PLUS, VENEERED and PAINTED surface finish
- door leaf (slab) equipped with a **drop down seal**
- **Rw = 37dB acoustic insulation**
- **aluminium reinforced door frame**
- rated **leaf (slab) thickness: 50 mm**

Entrance internal doors intended for rooms in public buildings including offices, hotels, etc.

door width "60"-90" - 4 mechanical class according to PN-EN 1192:2001
door width "90 plus"-110" - 3 mechanical class according to PN-EN 1192:2001
acoustic insulation: **Rw= 37 dB, D₁-35, D₂-30**



HARMONY INVEST door, HARMONY INVEST aluminium door frame

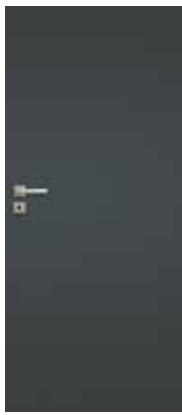

VERSION W00 / V00

COLOURS

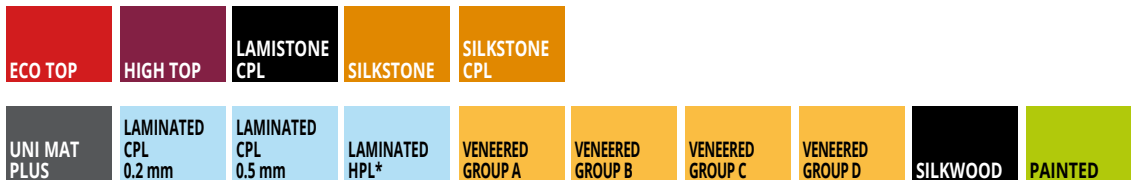

*available at an extra charge upon consultation with the Sales Department

DOOR FRAMES

HARMONY INVEST DOOR FRAME FOR SINGLE Leaf (slab) DOOR

for do-it-yourself painting	(anodized aluminum)	PAINTED white	PAINTED grey, beige	BLACK black, sage
(dimensions given for door leaf (slab))				
625-960 x 2040/2050 (2 concealed hinges)				
1025-1125 x 2040/2050 (3 concealed hinges)				
625-960 x 2140/2150 (3 concealed hinges)				
1025x1125 x 2140/2150 (3 concealed hinges)				
625-960 x 2240/2250 (3 concealed hinges)				
1025x1125x2240/2250 (3 concealed hinges)				
625-960 x 2340 /2350 (3 concealed hinges)				
1025-1125 x2340/2350 (3 concealed hinges)				
625-960 x 2440/2450 (3 concealed hinges)				
1025-1125x 2440/2450 (3 concealed hinges)				

HARMONY INVEST door (door openable inwards)

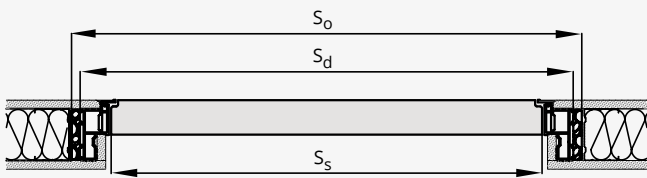

HARMONY INVEST door (door openable outwards)

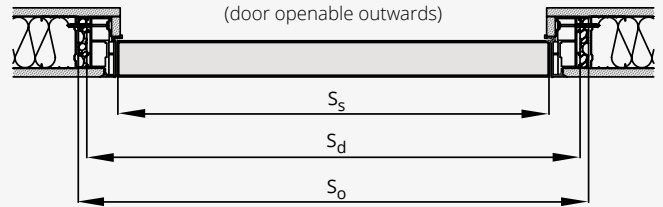

DOOR OPENABLE INWARDS ODW

	WIDTH [MM]			HEIGHT [MM]		
	Ss	Sd	So	Hs	Hd	Ho
"60"	625	715	735	1950	2002	2015
"70"	725	815	835	2050 - standard	2102	2115
"80"	825	915	935	2150	2202	2215
"90"	925	1015	1035	2250	2302	2315
"90 plus" *	960	1050	1070	2350	2402	2415
"100"	1025	1115	1135	2450	2502	2515
"110"	1125	1215	1235			

DOOR OPENABLE OUTWARDS ODZ

	WIDTH [MM]			HEIGHT [MM]		
	Ss	Sd	So	Hs	Hd	Ho
"60"	625	715	735	1940	1992	2005
"70"	725	815	835	2040 - standard	2092	2105
"80"	825	915	935	2140	2192	2205
"90"	925	1015	1035	2240	2292	2305
"90 plus" *	960	1050	1070	2340	2392	2405
"100"	1025	1115	1135	2440	2492	2505
"110"	1125	1215	1235			

* investment width

So - installation hole width

Ss - door leaf (slab) width

Sd - door frame external width

Ho - installation hole height

Hs - door leaf (slab) height

Hd - door frame external height

EQUIPMENT

STANDARD

- magnetic mortise lock, key-operated (spacing: 90 mm), for a cylinder (spacing: 85 mm) or a bathroom lock (spacing: 90 mm)
- anodized aluminum door frame or for do-it-yourself painting - TECTUS TE 340 satin chrome hinges, silver hook plate
- painted door frame in a colour of RAL 9003 - TECTUS TE 340 satin chrome hinges, chrome satin hook plate
- painted door frame in a colour of RAL 9005 - TECTUS TE 340 black hinges, black hook plate
- SIMONSWERK TECTUS TE 340 type concealed hinges (3D adjustable) ("60"- "90" - 2 pcs, "100"- "110" - 3 pcs), higher door - 3 pcs
- drop down seal
- recuperation trim*

ADDITIONAL (available at an extra charge)

- CPL laminate 0.5 mm ("60" - "90")
- CPL laminate 0.7 mm ("60" - "90")
- CPL laminate 0.5 mm ("90+" - "110")
- CPL laminate 0.7 mm ("90+" - "110")

SILKSTONE CPL colours

- GEZE Boxer 2-4 concealed door closer
- "100" width
- "110" width
- ventilation trim*
- mortise sash lock
- electric strikes in NC and NO versions
- higher door - 2150/2140
- higher door - 2250/2240
- higher door - 2350/2340
- higher door - 2450/2440

*doors with ventilation trim or undercut do not have a drop seal and the declared acoustic and air permeability parameters. matching wall panel grain to the door as per pattern (tolerance of up to 10 mm)

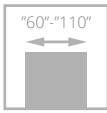

HARMONY INVEST ULTRA door with HARMONY ULTRA aluminium door frame

HARMONY INVEST ULTRA



- **concealed door frame without a lintel**
- **the latest trend in design, perfect matching the interiors**

- **solid construction – wooden rail and stile set** reinforced with steel bars
- **abundant colours** with the ECO TOP, LAMINATED CPL, LAMISTONE CPL, SILKSTONE, UNI MAT PLUS, VENEERED and PAINTED surface finish
- **aluminium frame**, reinforced
- **rated leaf (slab) thickness: 50 mm**

Entrance internal doors intended for rooms in public buildings including offices, hotels, etc.

door width "60" - "90" - 4 mechanical class according to PN-EN 1192:2001
door width "90 plus" - "110" - 3 mechanical class according to PN-EN 1192:2001



HARMONY INVEST ULTRA door with HARMONY ULTRA aluminium door frame

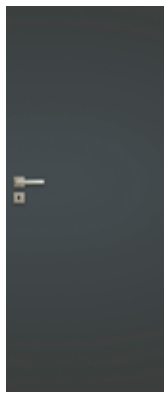

VERSION W00

COLOURS



*available at an extra charge upon consultation with the Sales Department

DOOR FRAMES

HARMONY INVEST ULTRA DOOR FRAME FOR SINGLE DOOR

leaf (slab) dimensions [mm]	raw for do-it-yourself painting	anodized aluminum	PAINTED white	PAINTED grey, beige	BLACK black, sage
	625-960 x 2040/2050 (2 hinges)				
	1025-1125 x 2040/2050 (3 hinges)				
	625-1125 x 2140/2050 (3 hinges)				
	625-1125 x 2240/2250 (3 hinges)				
	625-1125 x 2340/2350 (3 hinges)				
	625-1125 x 2440/2450 (3 hinges)				

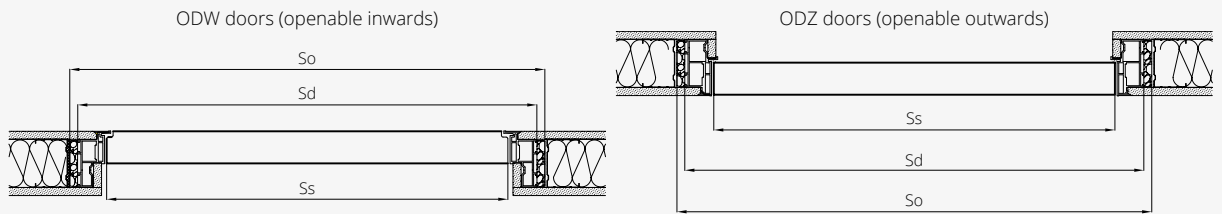

DOOR OPENABLE INWARDS ODW / OUTWARDS ODZ						
	WIDTH [MM]			HEIGHT [MM]		
	Ss	Sd	So	Hs	Hd	Ho
"60"	625	715	735	1940	1952	1955
"70"	725	815	835	2040 - standard	2052	2055
"80"	825	915	935	2140	2152	2155
"90"	925	1015	1035	2240	2252	2255
"90 plus"	960	1050	1070	2340	2352	2355
"100"	1025	1115	1135	2440	2452	2455
"110"	1125	1215	1235			

So - installation hole width
Ss - door leaf (slab) width
Sd - door frame external width

Ho - installation hole height
Hs - door leaf (slab) height
Hd - door frame external height

* investment width - version "90 plus" allows getting a clear opening of min. 900 mm when the door leaf (slab) is opened at an angle of 90°

EQUIPMENT

STANDARD

magnetic mortise lock, key-operated (spacing: 90 mm), for a cylinder (spacing: 85 mm) or a bathroom lock (spacing: 90 mm)
anodized aluminum door frame or for do-it-yourself painting - TECTUS TE 340 satin chrome hinges, silver hook plate
painted door frame in a colour of RAL 9003 - TECTUS TE 340 satin chrome hinges, chrome satin hook plate
SIMONSWERK TECTUS TE 340 type concealed hinges (3D adjustable) ("60"- "90" - 2 pcs, "100"- "110" - 3 pcs), higher door - 3 pcs
recuperation trim

ADDITIONAL (available at an extra charge)

TECTUS TE 340 lock colour replaced with black colour
CPL laminate 0.5 mm ("60" - "90")
CPL laminate 0.7 mm ("60" - "90")

CPL laminate 0.5 mm ("90+" - "110")
CPL laminate 0.7 mm ("90+" - "110")
SILKSTONE CPL colours
"100" width
"110" width
ventilation trim
mortise sash lock
electric strikes in NC and NO versions
higher door - 2150/2140
higher door - 2250/2240
higher door - 2350/2340
higher door - 2450/2440

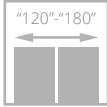
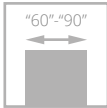

FIORD



- **solid construction – wooden rail and stile set**
- **3 - layer painting system** - colour fastness for many years
- wide **RAL and NCS colours palette**
- **K and C type adjustable and DUO type concealed hinges**
- door available in **10 working days** under the "fast delivery" promotion



glazing, spacer frame



DUO concealed hinge, white – option for non-rebated system



door leaf (slab) profile

FIORD door, 00 version, SYSTEM DIN DUO adjustable door frame



FIORD door, 00 version, adjustable door frame



VERSION **00 / V03** **01 / V3S1** **03 / V3S3** **04 / V3SD**

COLOURS



Applicable to Fiord 00 leaves and DIN, DIN DUO, Vertigo frames.

OPTIONAL COLOURS

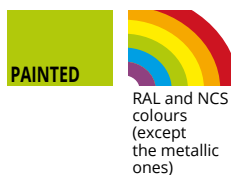

DOOR FRAMES

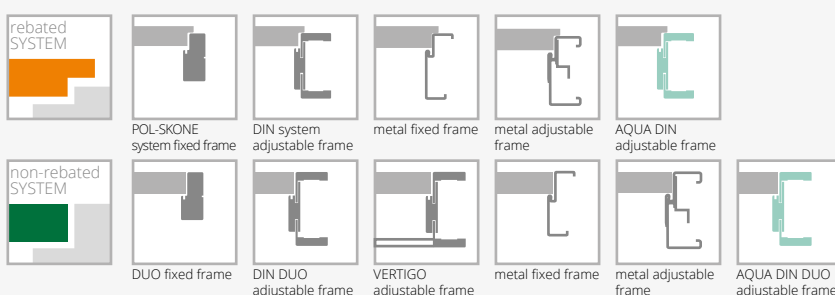

EQUIPMENT

STANDARD
white matt or transparent 4 mm thick glass
version 04: white matt tempered 4 mm thick glass
single-point mortise lock, spacing: 72 mm (rebated system) or magnetic mortise lock (non-rebated system), key-operated (spacing: 90 mm), for a cylinder (spacing: 85 mm) or a bathroom lock (spacing: 90 mm)
hinges: type K – for the DIN system door frame, type C – for the wooden door frame, type M – for the metal door frame or the concealed DUO satin nickel ("60"-80" – 2 pcs, "90" – 3 pcs) in case of door leaf (slab) with door closer and DIN system or metal frame to be used T type hinges ("60"-80" – 3 pcs, "90" – 4 pcs) - replacement
of standard hinges with hinge type T for an extra charge
BLACK collection: standard magnetic lock face plate and DUO hinges are in the colour of black

ADDITIONAL (available at an extra charge)
recuperation trim
solid chipboard in-fill (third hinge recommended)

third hinge in the door leaf (slab):
type M, type C, type K for a width of "60"-80"
concealed DUO type for a width of "60"-80"
the DUO hinge replaced with white or black colour
rebated system BLACK collection
the lock colour replaced with black colour
the DUO lock colour replaced with black or golden gloss colour
rail and stile set (allowing the user to shorten the door leaf (slab) by max. 50 mm on a do-it-yourself basis)
reinforcement for door closer
bottom rail and stile set protection against excessive moisture impact (not applicable to leaves with ventilation trim)
door lower by 50 mm or 100 mm (rebated system)
door lower by 55 mm or 100 mm (non-rebated system)
ventilation trim (p. 159)
tempered transparent 4 mm thick glass

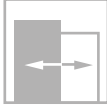

CAMBIO door, 00 version, SYSTEM DIN adjustable door frame

CAMBIO



- **solid construction – wooden rail and stile set**
- **3 - layer painting system** - colour fastness for many years
- wide **RAL and NCS colours palette**
- **K and C type adjustable and DUO type concealed hinges**



DUO concealed hinge, black – standard for the non-rebated system, collection BLACK

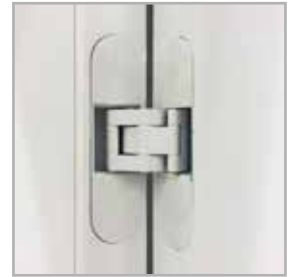

DUO concealed hinge, white – option for non-rebated system



leaf (slab) laminated edge in the colour of black, graphite or grey – option (not applicable to the BLACK surface)



CAMBIO door, 00 version, DIN DUO SYSTEM door frame



VERSION **00 / V00** **02 / V2S** **03SD / V3SD** **04 / V4SD** **05 / V5SD**

COLOURS

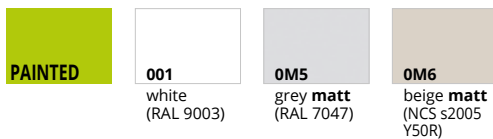

Applicable to Cambio leaves and DIN, DIN DUO and Vertigo frames.

OPTIONAL COLOURS

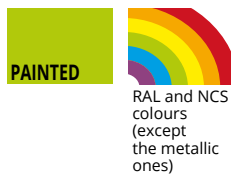

DOOR FRAMES

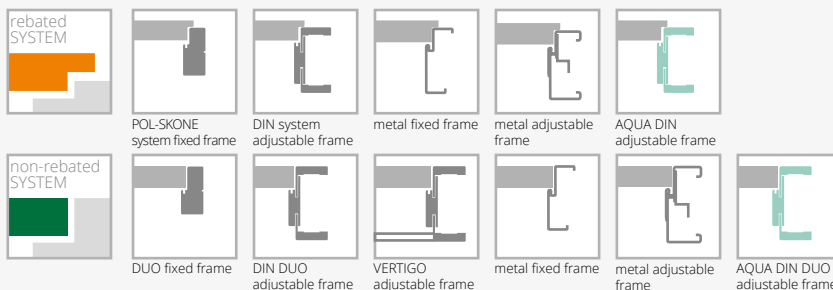

EQUIPMENT

STANDARD
white matt or transparent 4 mm thick glass
version 03SD: white matt tempered glass
single-point mortise lock, spacing: 72 mm (rebated system) or magnetic mortise lock (non-rebated system), key-operated (spacing: 90 mm), for a cylinder (spacing: 85 mm) or a bathroom lock (spacing: 90 mm)
hinges: type K - for the DIN system door frame, type C - for the wooden door frame, type M - for the metal door frame or the concealed DUO satin nickel ("60"-80" - 2 pcs, "90" - 3 pcs)
in case of door leaf (slab) with door closer and DIN system or metal frame to be used T type hinges ("60"-80" - 3 pcs, "90"-110" - 4 pcs) - replacement of standard hinges with hinge type T for an extra charge
BLACK collection: standard magnetic lock face plate and DUO hinges are in the colour of black
ADDITIONAL (available at an extra charge)
size "100" (glazing decoration as in "90")
size "110" (glazing decoration as in "90")
REVES system (version 00)
recuperation trim
perforated chipboard in-fill
solid chipboard in-fill (third hinge recommended)
third hinge in the door leaf (slab) or adjustable pivot hinge:
type M, type C, type K for a width of "60"-80"
concealed DUO type for a width of "60"-80"

the DUO hinge replaced with white or black colour
the DUO lock colour replaced with black or golden gloss colour
rebated system BLACK collection
the lock colour replaced with black colour
rail and stile set (allowing the user to shorten the door leaf (slab) by max. 50 mm on a do-it-yourself basis)
rail and stile set (allowing the user to shorten the door leaf (slab) by max. 90 mm on a do-it-yourself basis)
reinforcement for door closer
bottom rail and stile set protection against excessive moisture impact (not applicable to leaves with ventilation trim)
door lower by 50 mm or 100 mm (rebated system)
door lower by 55 mm or 100 mm (non-rebated system)
door higher by 50 mm or 100 mm (third hinge in the door leaf (slab) is required)
door higher by 150 mm or 200 mm (third hinge in the door leaf (slab) is required)
ventilation trim (p. 159)
tempered glass: versions 02, 04, 05
leaf (slab) edge in the colour of black, grey or graphite (not applicable to REVES system)
tempered transparent 4 mm thick glass

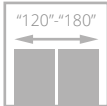
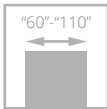

SIMPLE door, 00 version, SYSTEM DIN adjustable door frame

SIMPLE



- **solid construction - wooden rail and stile set**
- **3 - layer painting system** - colour fastness for many years
- wide **RAL and NCS colours palette**
- **K and C type adjustable and DUO type concealed hinges**



milled version view



DUO concealed hinge, white - option for non-rebated system



new type of milling



leaf (slab) laminated edge in the colour of black, graphite or grey - option (not applicable to the BLACK surface)



SIMPLE door, 02 version (door on the left side), 00 version (door on the right side), SYSTEM DIN adjustable door frame



VERSION **00 / VF0** **01 / VF1SD** **02 / VF2SD** **03 / VF4SD** **04 / VF4SM**

COLOURS

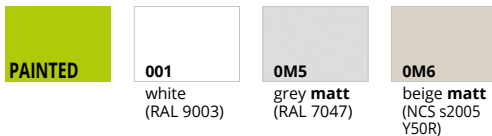

Applicable to Simple leaves and DIN, DIN DUO and Vertigo frames.

HIGHER DOOR

00 / V00

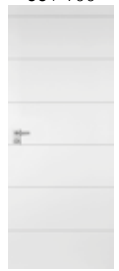

higher by min. 100 mm

OPTIONAL COLOURS

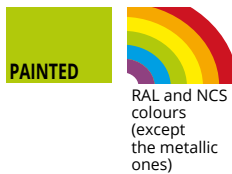

DOOR FRAMES

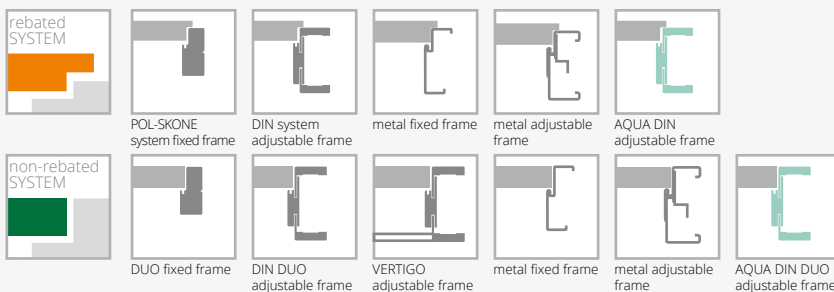

EQUIPMENT

STANDARD
 white matt or transparent 4 mm thick glass
 for the 01 and 02 model: white matt tempered glass, thickness: 4 mm
 single-point mortise lock, spacing: 72 mm (rebated system) or magnetic mortise lock (non-rebated system), key-operated (spacing: 90 mm), for a cylinder (spacing: 85 mm) or a bathroom lock (spacing: 90 mm)
 hinges: type K - for the DIN system door frame, type C - for the wooden door frame, type M - for the metal door frame or the concealed DUO satin nickel ("60"-80" - 2 pcs, "90" - 3 pcs) in case of door leaf (slab) with door closer and DIN system or metal frame to be used T type hinges ("60"-80" - 3 pcs, "90"-110" - 4 pcs) - replacement of standard hinges with hinge type T for an extra charge
BLACK collection: standard magnetic lock face plate and DUO hinges are in the colour of black
ADDITIONAL (available at an extra charge)
 size "100" (glazing decoration as in "90")
 size "110" (glazing decoration as in "90")
 REVES system (version 00)
 recuperation trim
 perforated chipboard in-fill
 solid chipboard in-fill (third hinge recommended)
 third hinge in the door leaf (slab) or adjustable pivot hinge:
 type M, type C, type K a width of "60"-80"
 concealed DUO type for a width of "60"-80"

the DUO hinge replaced with white or black colour
 rebated system BLACK collection
 the lock colour replaced with black colour
 rail and stile set (allowing the user to shorten the door leaf (slab) by max. 50 mm on a do-it-yourself basis)
 rail and stile set (allowing the user to shorten the door leaf (slab) by max. 90 mm on a do-it-yourself basis)
 reinforcement for door closer
 bottom rail and stile set protection against excessive moisture impact (not applicable to leaves with ventilation trim)
 door lower by 50 mm or 100 mm (rebated system)
 door lower by 55 mm or 100 mm (non-rebated system)
 door higher by 50 mm or 100 mm (third hinge in the door leaf (slab) is required)
 door higher by 150 mm or 200 mm (third hinge in the door leaf (slab) is required)
 ventilation trim (p. 159)
 leaf (slab) edge in the colour of black, grey or graphite (not applicable to REVES system)
 tempered glass (version 03, 04)
 tempered transparent 4 mm thick glass (version 01, 02)

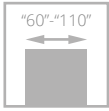

SUBITO door, 07 version, SYSTEM DIN adjustable door frame

SUBITO



- **solid construction – wooden rail and stile set**
- **3-layer painting system** - colour fastness for many years
- wide **RAL and NCS colours palette**
- K and C type **adjustable** and DUO type concealed **hinges**



leaf (slab) laminated edge in the colour of black, graphite or grey – option (not applicable to the BLACK surface)



SUBITO door, 07 version, SYSTEM DIN adjustable door frame

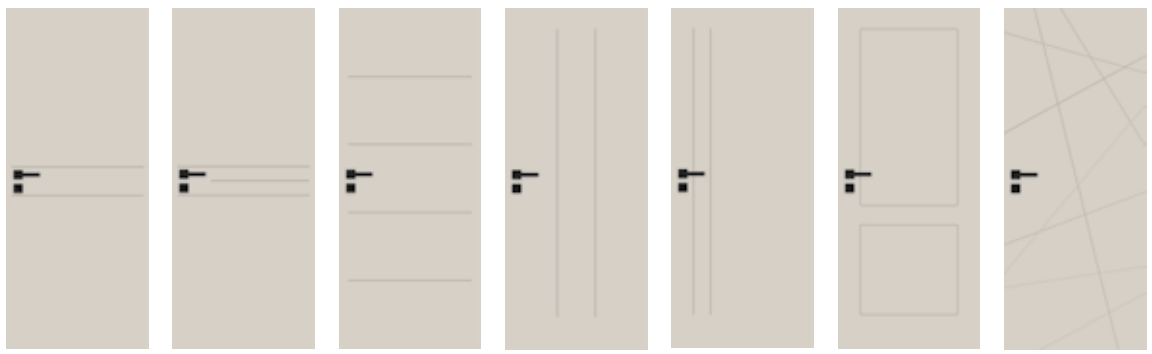

VERSION **01 / VF1** **02 / VF2** **03 / VF3** **04 / VF14** **05 / VF15** **06 / VF9** **07 / VF16**

COLOURS

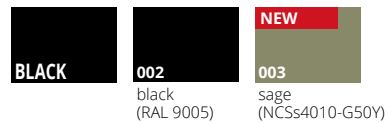
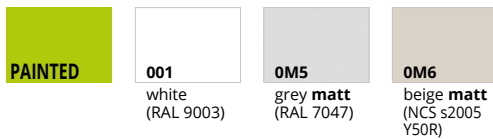

Applicable to Subito leaves and DIN, DIN DUO and Vertigo frames.

OPTIONAL COLOURS

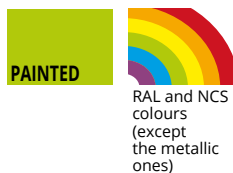

RAL and NCS colours (except the metallic ones)

DOOR FRAMES

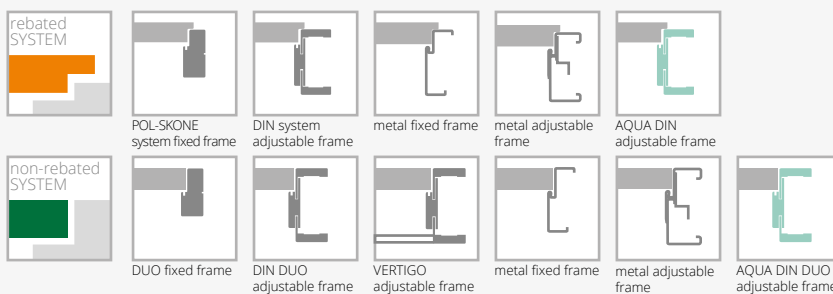

EQUIPMENT

STANDARD
 single-point mortise lock, spacing: 72 mm (rebated system) or magnetic mortise lock (non-rebated system), key-operated (spacing: 90 mm), for a cylinder (spacing: 85 mm) or a bathroom lock (spacing: 90 mm)
 hinges: silver type K – for the DIN system door frame, silver type C – for the wooden door frame, type M – for the metal door frame or the concealed DUO satin nickel ("60"-80" – 2 pcs, "80"-90" – 3 pcs)
 in case of door leaf (slab) with door closer and DIN system or metal frame T type hinges should be used ("60"-80" – 3 pcs, "90"-110" – 4 pcs) - replacement of standard hinges with hinge type T for an extra charge
 BLACK collection: standard magnetic lock face plate and DUO hinges are in the colour of black
 version 07 - in case of double doors it is possible to order symmetric division: "60"+"60", "70"+"70", "80"+"80", "90"+"90"
 no possibility of ordering asymmetric double doors (refers to 07 version)

ADDITIONAL (available at an extra charge)
 size "100"
 size "110"
 REVES system
 recuperation trim
 perforated chipboard in-fill

solid chipboard in-fill (third hinge recommended)
 third hinge in the door leaf (slab) or adjustable pivot hinge:
 type M, type C, type K a width of "60"-80"
 concealed DUO type for a width of "60"-80"
 the DUO hinge replaced with white or black colour
 rebated system BLACK collection:
 the lock colour replaced with black colour
 rail and stile set (allowing the user to shorten the door leaf (slab) by max. 50 mm on a do-it-yourself basis)
 rail and stile set (allowing the user to shorten the door leaf (slab) by max. 90 mm on a do-it-yourself basis)
 reinforcement for door closer
 bottom rail and stile set protection against excessive moisture impact (not applicable to leaves with ventilation trim)
 door lower by 50 mm or 100 mm (rebated system)
 door lower by 55 mm or 100 mm (non-rebated system)
 door higher by 50 mm or 100 mm (third hinge in the door leaf (slab) is required)
 door higher by 150 mm or 200 mm (third hinge in the door leaf (slab) is required)
 ventilation trim (p. 159)
 leaf (slab) edge in the colour of black, grey or graphite (not applicable to REVES system)

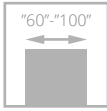

SUBLIME

NEW
COLOUR



- **solid construction – wooden rail and stile set**
- stable perforated **chipboard in-fill**
- **3 - layer painting system** - colour fastness for many years
- wide **RAL and NCS colours palette**
- **T, C type reinforced and DUO type adjustable hinges**



milling on the door leaf (slab) surface,
30 mm wide on versions B9



milling on the door leaf (slab) surface,
15 mm wide on versions B12



milling on the door leaf (slab) surface,
6 mm wide on versions A1-A3 and
B2-B6



leaf (slab) laminated edge in the
colour of black, graphite or grey –
option (not applicable to the BLACK
surface)

SUBLIME door, B12 version, SYSTEM DIN adjustable door frame



SUBLIME door, B12 version, SYSTEM DIN adjustable door frame

REBATED SYSTEM



VERSION A0 / V00 A1 / VF1 A2 / VF2 A3 / VF3 B2 / VF4 B4 / VF5 B6 / VF6 B9 / VF7 B12 / VF8

DOOR HIGHER

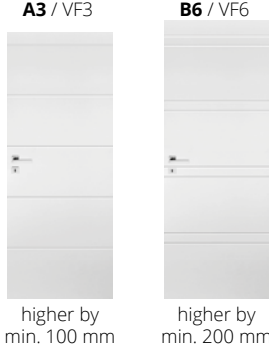

VENTILATION OPTIONS
version B12 / VF8



COLOURS

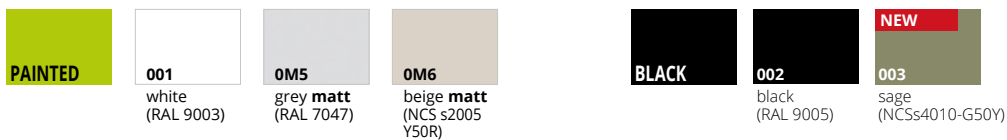

OPTIONAL COLOURS

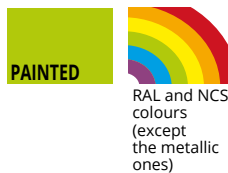

Applicable to Sublime leaves and DIN, DIN DUO and Vertigo frames.

DOOR FRAMES

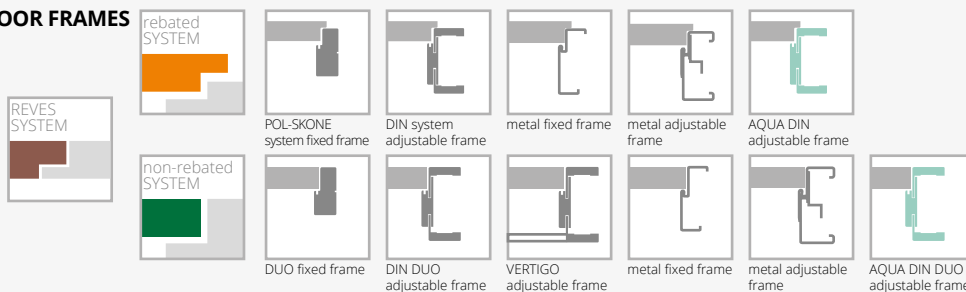

EQUIPMENT

STANDARD	
single-point mortise lock, spacing: 72 mm (rebated system) or magnetic mortise lock (non-rebated system), key-operated (spacing: 90 mm), for a cylinder (spacing: 85 mm) or a bathroom lock (spacing: 90 mm)	the DUO hinge replaced with white or black colour
hinges: type T – for the DIN system door frame and the metal door frame, type C – for the wooden door frame ("60"-80" – 2 pcs, "90" – 3 pcs) or the concealed DUO satin nickel ("60"-70" – 2 pcs, "80"-90" – 3 pcs)	the DUO lock colour replaced with black or golden gloss colour
door higher than standard – a non-standard milled versions	rebated system BLACK collection
BLACK collection: standard magnetic lock face plate and DUO hinges are in the colour of black	the T hinge colour replaced with black colour
versions B9 - wider cut, versions B12, A1-A3, B2-B6 - narrower cut	the lock colour replaced with black colour
ADDITIONAL (available at an extra charge)	rail and stile set (allowing the user to shorten the door leaf (slab) by max. 50 mm on a do-it-yourself basis)
size "100"	rail and stile set (allowing the user to shorten the door leaf (slab) by max. 90 mm on a do-it-yourself basis)
REVES system	reinforcement for door closer
recuperation trim	ventilation trim (p. 159)
solid chipboard in-fill (third hinge recommended)	bottom rail and stile set protection against excessive moisture impact (not applicable to leaves with ventilation trim)
third hinge in the door leaf (slab):	door lower by 50 mm or 100 mm (rebated system)
type C for a width of "60"-80"	door lower by 55 mm or 100 mm (non-rebated system)
type T for a width of "60"-80"	door higher by 50 mm or 100 mm (third hinge in the door leaf (slab) is required)
concealed DUO type for a width of "60"-70"	door higher by 150 mm or 200 mm (third hinge in the door leaf (slab) is required)
	leaf (slab) edge in the colour of black, grey or graphite (not applicable to REVES system)

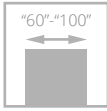

TIARA

NEW
COLOUR



- **solid construction – wooden rail and stile set**
- stable solid **chipboard in-fill**
- **3 - layer painting system** - colour fastness for many years
- wide **RAL and NCS colours palette**
- **K and C type adjustable and DUO type concealed hinges**



aluminium decors on the leaf (slab) surface in the colour of matt chrome (standard)



DUO concealed hinge, white – option for non-rebated system

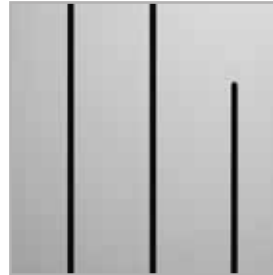

aluminium decors on the leaf (slab) surface in the colour of black, golden gloss, chrome gloss (option) – p. 163



DUO concealed hinge, black – standard for the non-rebated system, collection BLACK

TIARA door, W02 version, RAL 5011, SYSTEM DIN adjustable door frame



TIARA door, W02 version, DIN DUO adjustable door frame



VERSION W01 / VD1 W02 / VD2 W07 / VD7



VERSION W03 / VD3 W04 / VD4 W06 / VD6 W08 / VD8



leaf (slab) laminated edge in the colour of black, graphite or grey – option (not applicable to the BLACK surface)

COLOURS

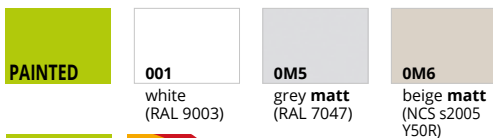

OPTIONAL COLOURS



Applicable to Tiara leaves and DIN, DIN DUO and Vertigo frames.

DOOR FRAMES

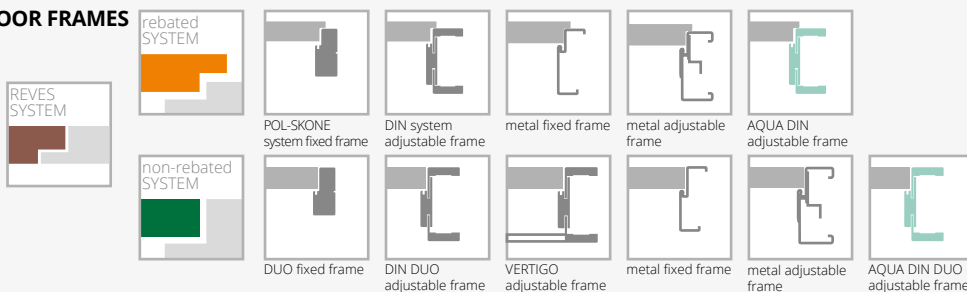

EQUIPMENT

STANDARD
 single-point mortise lock, spacing: 72 mm (rebated system) or magnetic mortise lock (non-rebated system), key-operated (spacing: 90 mm), for a cylinder (spacing: 85 mm) or a bathroom lock (spacing: 90 mm)
 hinges: silver type K – for the DIN system door frame, silver type C – for the wooden door frame, type M – for the metal door frame or the concealed DUO satin nickel ("60"- "70" – 2 pcs, "80"- "90" – 3 pcs)
 BLACK collection: standard magnetic lock face plate and DUO hinges are in the colour of black
 version W08: no possibility to use a ventilation slot or a ventilation grill

ADDITIONAL (available at an extra charge)
 size "100"
 REVES system
 recuperation trim
 third hinge in the door leaf (slab):
 type K, type C, type M for a width of "60"- "80"
 concealed DUO type for a width of "60"- "70"
 the DUO hinge replaced with white or black colour

rebated system BLACK collection
 the lock colour replaced with black colour
 rail and stile set (allowing the user to shorten the door leaf (slab) by max. 50 mm on a do-it-yourself basis) (not applicable to W08 version)
 rail and stile set (allowing the user to shorten the door leaf (slab) by max. 90 mm on a do-it-yourself basis) (not applicable to W08 version)
 bottom rail and stile set protection against excessive moisture impact (not applicable to leaves with ventilation trim)
 door lower by 50 mm or 100 mm (rebated system)
 door lower by 55 mm or 100 mm (non-rebated system)
 door higher by 50 mm or 100 mm (third hinge in the door leaf (slab) is required)
 door higher by 150 mm or 200 mm (third hinge in the door leaf (slab) is required)
 ventilation trim (p. 159)
 aluminium decorative strips in black, golden gloss or chrome gloss
 change of the DUO lock colour to black or golden gloss
 leaf (slab) edge in the colour of black, grey or graphite (not applicable to REVES system)

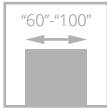

ESTATO door, A02 version, SYSTEM DIN adjustable door frame

ESTATO



- **solid construction – wooden rail and stile set**
- stable perforated **chipboard in-fill**
- **3 - layer painting system** - colour fastness for many years
- wide **RAL and NCS colours palette**
- **security glass pane**, white matt thickness: **6 mm or 44.2 laminated glass in the colour of black or white**
- **T, C type reinforced and DUO type adjustable hinges**



milled version on the door leaf (slab) surface



laminated glass in the colour of white matt



leaf (slab) laminated edge in the colour of black, graphite or grey - option (not applicable to the BLACK surface)



pane in the colour of black - optional



ESTATO door, A01 version, SYSTEM DIN adjustable door frame



WHITE MATT TEMPERED GLASS

VERSION **A01 / V1SA** **A02 / V2SA** **A03 / V3SA** **B1 / VF11** **B2 / VF12** **B3 / VF13**



BLACK LAMINATED GLASS

WHITE MATT LAMINATED GLASS

VERSION **A01 / V1SA** **A02 / V2SA** **A03 / V3SA** **A01 / V1SA** **A02 / V2SA** **A03 / V3SA**

COLOURS

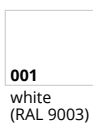

OPTIONAL COLOURS



RAL and NCS colours (except the metallic ones)

DOOR FRAMES



POL-SKONE system fixed frame

DIN system adjustable frame

metal fixed frame

metal adjustable frame

AQUA DIN adjustable frame

DUO fixed frame

DIN DUO adjustable frame

VERTIGO adjustable frame

metal fixed frame

metal adjustable frame

AQUA DIN DUO adjustable frame

EQUIPMENT

STANDARD

white matt tempered glass, thickness: 6 mm (versions A01-58 mm, A02-208 mm, A03-280 mm)*
laminated glass 44.2 in the colour of black or white matt, 8.5 mm thick (versions A01-54 mm, A02-205 mm, A03-276 mm)
single-point mortise lock, spacing: 72 mm (rebated system) or magnetic mortise lock (non-rebated system), key-operated (spacing: 90 mm), for a cylinder (spacing: 85 mm) or a bathroom lock (spacing: 90 mm)
hinges: type T – for the DIN system door frame and the metal door frame, type C – for the wooden door frame ("60"-80" – 2 pcs, "90" – 3 pcs) or the concealed DUO satin nickel for the non-rebated system ("60"-70" – 2 pcs, "80"-90" – 3 pcs)

ADDITIONAL (available at an extra charge)

size "100"
REVES system
perforated chipboard in-fill (hinge in the door leaf (slab) is required)
third hinge in the door leaf (slab):
type C for a width of "60"-80"
type T for a width of "60"-80"
concealed DUO type for a width of "60"-70"
the DUO hinge replaced with white or black colour
rebated system BLACK collection
the T hinge colour replaced with black colour
the lock colour replaced with black colour
rail and stile set (allowing the user to shorten the door leaf (slab) by max. 50 mm on a do-it-yourself basis) (not applicable to versions A01, A02, A03)
rail and stile set (allowing the user to shorten the door leaf (slab) by max. 90 mm on a do-it-yourself basis) (not applicable to versions A01, A02, A03)

reinforcement for door closer (not applicable to versions A01, A02, A03)
bottom rail and stile set protection against excessive moisture impact (not applicable to leaves with ventilation trim) (not applicable to versions A01, A02, A03)
door lower by 50 mm or 100 mm (rebated system) (not applicable to the version A01, A02, A03)
door lower by 55 mm or 100 mm (non-rebated system) (not applicable to versions A01, A02, A03)
door higher by 50 mm or 100 mm (third hinge in the door leaf (slab) is required) (not applicable to versions A01, A02, A03)
door higher by 150 mm or 200 mm (third hinge in the door leaf (slab) is required) (not applicable to versions A01, A02, A03)
version A01, A02, A03 door lower by 50 mm (rebated system)
version A01, A02, A03 door lower by 55 mm (non-rebated system)
version A01, A02, A03 door higher by 100 mm (third hinge in the door leaf (slab) is required)
version A01, A02, A03 door higher by 200 mm (third hinge in the door leaf (slab) is required)
ventilation trim (applicable to versions B1, B2, B3) (p. 159)
ventilation trim A01 with the "60" - "100" widths (p. 159)
ventilation trim A02, A03 with the "70" - "100" widths (p. 159)
tempered 6 mm glass in the colour of graphite, brown
sliding system (not applicable to the version A01) p. 114-119
leaf (slab) edge in the colour of black, grey or graphite (not applicable to REVES system)

*+/- 2 mm tolerance

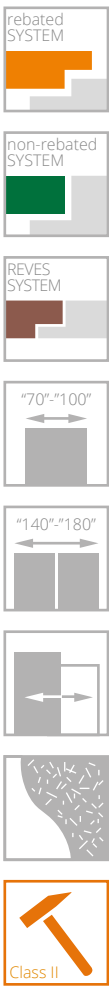

PALAZZO

**NEW
COLOUR**

- **solid construction – wooden rail and stile set**
- **unique** design
- **rebated** or **non-rebated** system
- **3 - layer painting system** - colour fastness for many years
- **large colours palette** - in standard white, grey matt, beige matt and optional black
- **K type adjustable** for the rebated door or **DUO type concealed hinges** for the not-rebated door



PALAZZO door, W00 version, SYSTEM DIN adjustable door frame

rail and stile set profile



PALAZZO door, W00 version, DIN adjustable door frame



VERSION **W00**

COLOURS

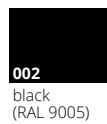

Applicable to DIN, DIN DUO and Vertigo frames.

OPTIONAL COLOURS



RAL and NCS colours (except the metallic ones)

DOOR FRAMES



DUO fixed frame

DIN DUO adjustable frame

VERTIGO adjustable frame

AQUA DIN DUO adjustable frame

EQUIPMENT

STANDARD

single-point mortise lock, spacing: 72 mm (rebated system) or magnetic mortise lock (non-rebated system), key-operated (spacing: 90 mm), for a cylinder (spacing: 85 mm) or a bathroom lock (spacing: 90 mm)
hinges: type K – for the DIN system door frame, type C – for the wooden door frame or the concealed DUO satin nickel ("70" – 2 pcs, "80"-"90" – 3 pcs)
door closer is not available

ADDITIONAL (available at an extra charge)

size "100"
REVES system
recuperation trim
third hinge in the door leaf (slab):
type C for a width of "70"-"80"
type K for a width of "70"-"80"
concealed DUO type for a width of "70"
the DUO hinge replaced with white or black colour
ventilation trim
bottom rail and stile set protection against excessive moisture impact (not applicable to leaves with ventilation trim)
door lower by 50 mm or 100 mm (rebated system)
door lower by 55 mm or 100 mm (non-rebated system)
door higher by 50 mm or 100 mm

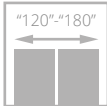
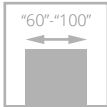

VERTIGO door, W03 version, SYSTEM DIN adjustable door frame

VERTIGO

NEW
COLOUR



- **solid construction – wooden rail and stile set**
- **3 - layer painting system** - colour fastness for many years
- wide **RAL and NCS colours palette**
- **security glass pane**, white matt thickness: 6 mm
- K and C type adjustable and DUO type concealed hinges



frame



DUO concealed hinge, white – option for non-rebated system



standard connection of architraves at an angle of 45° for the DIN DUO door frame



VERTIGO door, W02 version, VERTIGO adjustable door frame



VERSION **W00 / V01** **OSD / V1SD** **W02 / V02** **W02S1 / V2SD**



VERSION **W03 / V03** **W03S1 / V3S1** **W03S2 / V3S2** **W03S3 / V3S3**

COLOURS

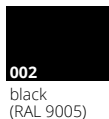

Applicable to Vertigo W00, W02, W03 leaves and DIN, DIN DUO and Vertigo frames.

OPTIONAL COLOURS



RAL and NCS colours (except the metallic ones)

DOOR FRAMES

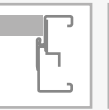
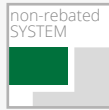

EQUIPMENT

STANDARD
white matt tempered glass, thickness: 6 mm
transparent pane cannot be used
single-point mortise lock, spacing: 72 mm (rebated system) or magnetic mortise lock (non-rebated system), key-operated (spacing: 90 mm), for a cylinder (spacing: 85 mm) or a bathroom lock (spacing: 90 mm)
hinges: type K – for the DIN system door frame, type C – for the wooden door frame, type M – for the metal door frame or the concealed DUO satin nickel ("60"- "80" – 2 pcs, "90" – 3 pcs)
door closer is not available
BLACK collection: standard magnetic lock face plate and DUO hinges are in the colour of black
ADDITIONAL (available at an extra charge)
size "100"
recuperation trim
REVES system (version W00, W02, W03) - the door opening angle is 87° above ZW5 range

third hinge in the door leaf (slab):
type K, type C, type M for a width of "60"- "80"
concealed DUO type for a width of "60"- "80"
the DUO hinge replaced with white or black colour
rebated system BLACK collection
the lock colour replaced with black colour
bottom rail and stile set protection against excessive moisture impact (not applicable to leaves with ventilation trim)
door lower by 50 mm (rebated system)
door lower by 55 mm (non-rebated system)
door higher by 50 mm or 100 mm (third hinge in the door leaf (slab) is required)
door higher by 150 mm or 200 mm (third hinge in the door leaf (slab) is required)
ventilation trim (p. 159)

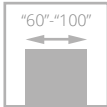

VILANO

NEW COLOUR



- **solid construction – wooden rail and stile set**
- **3 - layer painting system** - colour fastness for many years
- wide **RAL and NCS colours palette**
- **security glass pane**, white matt thickness: 6 mm
- K and C type adjustable and DUO type concealed hinges



DUO concealed hinge, white – option for non-rebated system



frame profile

VILANO door, W00 version, SYSTEM DIN adjustable door frame



VILANO door, W00 version, SYSTEM DIN adjustable door frame



VERSION W00 / V01

OSD / V1SD

COLOURS



001
white
(RAL 9003)



0M5
grey **matt**
(RAL 7047)

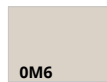

0M6
beige **matt**
(NCS s2005 Y50R)



BLACK



002
black
(RAL 9005)



NEW
003
sage
(NCSs4010-G50Y)

OPTIONAL COLOURS



RAL and NCS
colours
(except
the metallic
ones)

Applicable to Vilano W00 leaves and DIN,
DIN DUO and Vertigo frames.

DOOR FRAMES

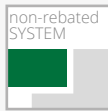

POL-SKONE
system fixed frame



DIN system
adjustable frame

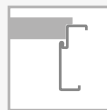

metal fixed frame

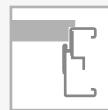

metal adjustable
frame



AQUA DIN
adjustable frame



DUO fixed frame



DIN DUO
adjustable frame



VERTIGO
adjustable frame



metal fixed frame



metal adjustable
frame



AQUA DIN DUO
adjustable frame

EQUIPMENT

STANDARD

white matt tempered glass, thickness: 6 mm
transparent pane cannot be used
single-point mortise lock, spacing: 72 mm (rebated system) or magnetic
mortise lock (non-rebated system), key-operated (spacing: 90 mm),
for a cylinder (spacing: 85 mm) or a bathroom lock (spacing: 90 mm)
hinges: type K - for the DIN system door frame, type C - for the
wooden door frame, type M - for the metal door frame or the
concealed DUO satin nickel ("60"- "80" - 2 pcs, "90" - 3 pcs)
door closer is not available

ADDITIONAL (available at an extra charge)

size "100"
recuperation trim
REVES system (version W00) (the door opening angle is 88°
above ZW4 range)
third hinge in the door leaf (slab):
type K, type C, type M for a width of "60"- "80"
concealed DUO type for a width of "60"- "80"
the DUO hinge replaced with white or black colour
rebated system BLACK collection
the lock colour replaced with black colour
bottom rail and stile set protection against excessive moisture impact
(not applicable to leaves with ventilation trim)
door lower by 50 mm (rebated system)
door lower by 55 mm (non-rebated system)
door higher by 50 mm or 100 mm
(third hinge in the door leaf (slab) is required)
door higher by 150 mm or 200 mm (third hinge in the
door leaf (slab) is required)
ventilation trim (p. 159)

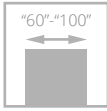

for door leaves with ventilation option



MODERN door, 02 version, SYSTEM DIN adjustable door frame

MODERN

NEW COLOUR



- **solid construction – wooden rail and stile set**
- **3 - layer painting system** - colour fastness for many years
- wide **RAL and NCS colours palette**
- K and C type adjustable and DUO type concealed hinges



rail and stile set profile



DUO concealed hinge, white – option for non-re-bated system



painted architrave and crown



MODERN door, 02 version with a crown, SYSTEM DIN adjustable door frame



VERSION **01 / V01** **01S6 / V1S6** **02 / V02** **02S6 / V2S6**



VERSION **05 / V05** **05S8 / V5S8** **08 / V08** **08S10 / V8S10**

COLOURS

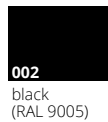

OPTIONAL COLOURS



RAL and NCS colours (except the metallic ones)

Applicable to Modern 01, 02, 05, 08 leaves and DIN, DIN DUO and Vertigo frames.

DOOR FRAMES

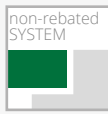

DUO fixed frame DIN DUO adjustable frame VERTIGO adjustable frame metal fixed frame metal adjustable frame AQUA DIN DUO adjustable frame

EQUIPMENT

STANDARD
white matt or transparent 4 mm thick glass
wooden muntins
single-point mortise lock, spacing: 72 mm (rebated system) or magnetic mortise lock (non-rebated system), key-operated (spacing: 90 mm), for a cylinder (spacing: 85 mm) or a bathroom lock (spacing: 90 mm)
hinges: type K – for the DIN system door frame, type C – for the wooden door frame, type M – for the metal door frame or the concealed DUO satin nickel ("60"-80" – 2 pcs, "90" – 3 pcs)
door closer is not available
BLACK collection: standard magnetic lock face plate and DUO hinges are in the colour of black

ADDITIONAL (available at an extra charge)
size "100"
recuperation trim
REVES system (version 01, 02, 05, 08)
third hinge in the door leaf (slab): type K, type M for a width of "60"-80"
concealed DUO type for a width of "60"-80"
the DUO hinge replaced with white or black colour
rebated system BLACK collection
the lock colour replaced with black colour
bottom rail and stile set protection against excessive moisture impact (not applicable to leaves with ventilation trim)
door lower by 50 mm (rebated system)
door lower by 55 mm (non-rebated system)
door higher by 50 mm or 100 mm (third hinge in the door leaf (slab) is required)
door higher by 150 mm or 200 mm (third hinge in the door leaf (slab) is required)
ventilation trim (p. 159)

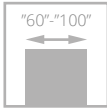

for door leaves with ventilation option



MODENA door, 02 version, SYSTEM DIN adjustable door frame

MODENA

NEW COLOUR

- **solid construction - wooden rail and stile set**
- **3 - layer painting system** - colour fastness for many years
- wide **RAL and NCS colours palette**
- K and C type adjustable and DUO type concealed hinges



rail and stile set profile





MODENA door, 08 version, SYSTEM DIN adjustable door frame





VERSION **02 / V02** **05 / V05** **08 / V08**

COLOURS

PAINTED

	001 white (RAL 9003)		0M5 grey matt (RAL 7047)		0M6 beige matt (NCS s2005 Y50R)
--	-----------------------------------	--	--	--	---

	002 black (RAL 9005)		003 sage (NCSs4010-G50Y)
--	-----------------------------------	--	---------------------------------------

OPTIONAL COLOURS

PAINTED











RAL and NCS colours (except the metallic ones)

Applicable to DIN, DIN DUO and Vertigo frames.

DOOR FRAMES



				
				
	POL-SKONE system fixed frame	DIN system adjustable frame	AQUA DIN adjustable frame	
	DUO fixed frame	DIN DUO adjustable frame	VERTIGO adjustable frame	AQUA DIN DUO adjustable frame

EQUIPMENT

STANDARD	ADDITIONAL (available at an extra charge)
single-point mortise lock, spacing: 72 mm (rebated system) or magnetic mortise lock (non-rebated system), key-operated (spacing: 90 mm), for a cylinder (spacing: 85 mm) or a bathroom lock (spacing: 90 mm)	size "100"
hinges: K type - for the DIN system door frame, C type - for the wooden door frame or the satin nickel DUO concealed ("60"- "80" - 2 pcs, "90" - 3 pcs)	recuperation trim
door closer is not available	REVES system
	third hinge in the door leaf (slab): type K, type C for a width of "60"- "80" concealed DUO type for a width of "60"- "80"
	the DUO hinge replaced with white or black colour
	ventilation trim (p. 159)
	bottom rail and stile set protection against excessive moisture impact (not applicable to leaves with ventilation trim)
	door lower by 50 mm or 100 mm (rebated system)
	door lower by 55 mm or 100 mm (non-rebated system)
	door higher by 50 mm or 100 mm (third hinge in the door leaf (slab) is required)
	door higher by 150 mm or 200 mm (third hinge in the door leaf (slab) is required)

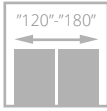
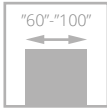

for door leaves with ventilation option

RAL 7035



MODESTO door, W03 version, SYSTEM DIN adjustable door frame

MODESTO

NEW

NEW COLOUR

- **solid construction - wooden rail and stile set**
- 3 - layer **painting system - colour fastness** for many years
- panel thickness: 12 mm
- wide **RAL and NCS colours palette**
- **K and C type adjustable** and **DUO type concealed hinges**



milling on the door leaf (slab) surface



MODESTO door, W04 version, SYSTEM DIN adjustable door frame



VERSION **W00** **W01** **W02** **W03** **W04**

COLOURS



DOOR FRAMES

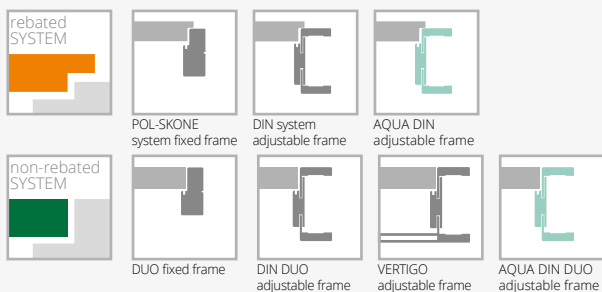

EQUIPMENT

STANDARD	ADDITIONAL (available at an extra charge)
single-point mortise lock, spacing: 72 mm (rebated system) or magnetic mortise lock (non-rebated system), key-operated (spacing: 90 mm), for a cylinder (spacing: 85 mm) or a bathroom lock (spacing: 90 mm)	size "100"
hinges: type K - for the DIN system door frame, type C - for the wooden door frame or the concealed DUO satin nickel ("60"- "80"- 2 pcs, "90" - 3 pcs)	REVES system
door closer is not available	recuperation trim
	third hinge in the door leaf (slab): type C for a width of "60"- "80" type K for a width of "60"- "80" concealed DUO type for a width of "60"- "80"
	the DUO hinge replaced with white or black colour
	ventilation trim
	bottom rail and stile set protection against excessive moisture impact (not applicable to leaves with ventilation trim)
	door lower by 50 mm or 100 mm (rebated system)
	door lower by 55 mm or 100 mm (non-rebated system)
	door higher by 50 mm or 100 mm (third hinge in the door leaf (slab) is required)
	door higher by 150 mm or 200 mm (third hinge in the door leaf (slab) is required)

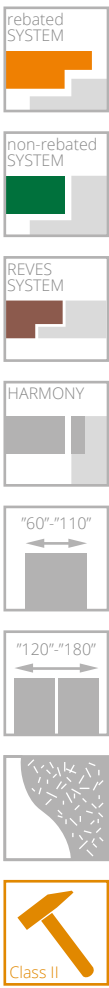

LOFTY



- **solid construction – wooden rail and stile set**
- stable solid **chipboard in-fill**
- adjustable reinforced hinge type T and adjustable DUO type in black

LOFTY door, W00 version, SYSTEM DIN adjustable door frame in black 244



LOFTY door, W00 version, SYSTEM DIN adjustable door frame in black 244



SET PRICE
 =
DOOR Leaf (slab) PRICE
 +
DIN / DIN DUO DOOR FRAME PRICE
 (black 244 or 644)
 or
HARMONY CONCEALED DOOR
FRAME PRICE (BLACK RAL 9005)
 or
METAL FRAME PRICE

VERSION W00 / V00

COLOURS



* available upon consultation with the Sales Department

DOOR FRAMES

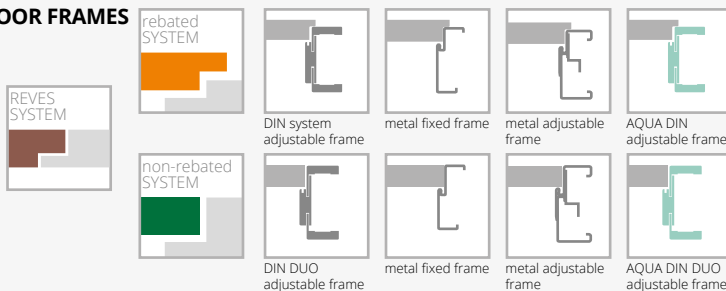

EQUIPMENT

STANDARD

single-point mortise lock, spacing: 72 mm (rebated system) or magnetic mortise lock (non-rebated system), key-operated (spacing: 90 mm), for a cylinder (spacing: 85 mm) or a bathroom lock (spacing: 90 mm)

hinges: type T - for the metal frame or concealed DUO in black ("60"- "80" - 2 pcs., "90" - 3 pcs.)

in case of door leaf (slab) with door closer and DIN system or metal frame T type hinges should be used ("60"- "80" - 3 pcs., "90"- "110" - 4 pcs) - replacement of standard hinges with hinge type T for an extra charge

ADDITIONAL (available at an extra charge)

size "100"

size "110"

recuperation trim

REVES system

third hinge in the door leaf (slab) or adjustable pivot hinge:
 type T in black for a width of "60"- "80"
 concealed DUO type in black for a width of "60"- "80"

rail and stile set (allowing the user to shorten the door leaf (slab) by max. 50 mm on a do-it-yourself basis)

rail and stile set (allowing the user to shorten the door leaf (slab) by max. 90 mm on a do-it-yourself basis)

reinforcement for door closer

bottom rail and stile set protection against excessive moisture impact

door lower by 50 mm or 100 mm (rebated system)

door lower by 55 mm or 100 mm (non-rebated system)

door higher by 50 mm or 100 mm (third hinge in the door leaf (slab) is required)

door higher by 150 mm or 200 mm (third hinge in the door leaf (slab) is required)

ventilation trim (p. 159)

leaf (slab) laminated edge in the colour of black

ABS edging in black or Polish oak (not applicable to REVES system)

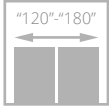
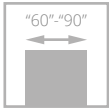

for door leaves with ventilation option



ARCO door, W03P version, SYSTEM DIN adjustable door frame

ARCO



- **constructed with a high quality** MDF rail and stile set
- FSC® Mix certificate only available upon request
- door available in **10 working days** under the "fast delivery" promotion



rail and stile set - vertical wood grain, cross rails and panel - horizontal wood grain



panels, glazing



available at an extra charge: **VSG 22.1 laminated glass in the colour of black**



ARCO door, W02 version (door on the left side and the right side), DIN adjustable door frame



The mark of responsible forestry

ARCO certified FSC® Mix available only on customer's request



VERSION **W02P / V02** **W2S / V2S2** **W02 / V2S5** **W2D / V1SD** **W03P / V03** **W3S / V3S2** **W03 / V3S5** **W5P / V4S2** **W5S / V4S4** **W05 / V4S3**



VERSION **W06 / V05** **W6S1 / V5S1** **W6S2 / V5S2** **W6S3 / V5S3** **W07 / V06** **W07S1 / V6S1** **W07S3 / V6S3** **W08 / V07** **W08S1 / V7S1** **W08S4 / V7S4**

COLOURS



DOOR FRAMES

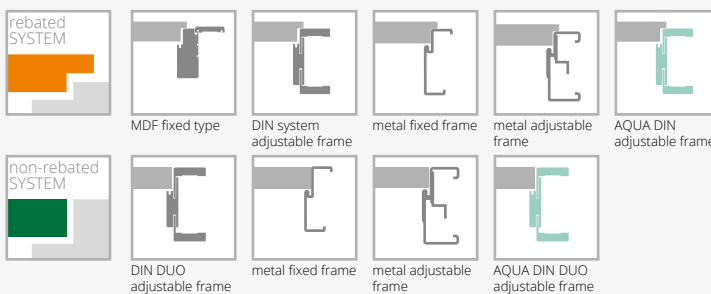

EQUIPMENT

STANDARD	ADDITIONAL (available at an extra charge)
white/brown matt or transparent 4 mm glass	recuperation trim (only standard height)
models W2D, W5S, W05, W6S1, W6S2, W6S3 standard: tempered glass	door lower by 50 mm (rebated system)
single-point mortise lock, spacing: 72 mm (rebated system) or magnetic mortise lock (non-rebated system), key-operated (spacing: 90 mm), for a cylinder (spacing: 85 mm) or a bathroom lock (spacing: 90 mm)	door lower by 55 mm (non-rebated system)
hinges: type B – for the DIN system door frame, type D – for the MDF, type M – for the metal door frame or the concealed DUO satin nickel ("60"-/90" – 3 pcs)	ventilation trim (p. 159)
door closer is not available	VSG 22.1 laminated white or transparent glass: version W02, W08, W03
drop seal is not available	tempered transparent 4 mm thick glass
	VSG 22.1 laminated black glass: version W02, W08, W03



INTER-AMBER



- **solid construction – wooden rail and stile set**
- **abundant colours** of ECO TOP and HIGH TOP surface finish
- **tempered glass pane** in AS4 and 03SD version in white or brown matt colour, thickness: 4 mm



INTER-AMBER door, F00 version, SYSTEM DIN adjustable door frame

muntin AS4



INTER-AMBER door, F06 version (door on the left side), A00 version (door on the right side), SYSTEM DIN adjustable door frame



VERSION **A00 / V00** **A01 / V2S** **AS4 / V2SD** **03SD / V3SD** **C00 / V03** **C01 / V3S1** **C02 / V3S2** **C03 / V3S3**



VERSION **F00 / V06** **F01 / V6S1** **F02 / V6S2** **F06 / V6S6** **04SD / V4SD** **05SD / V5SD**

COLOURS

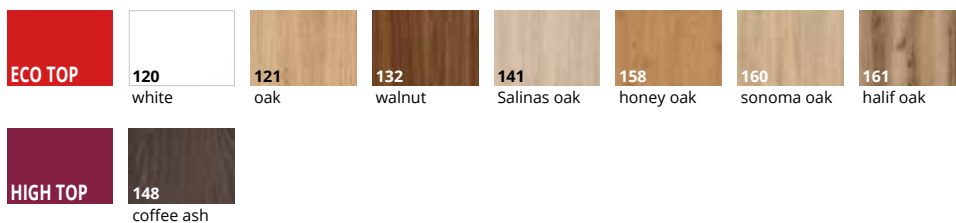

DOOR FRAMES

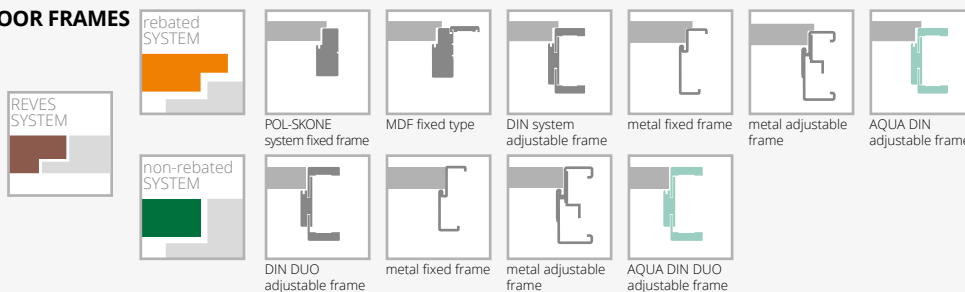

EQUIPMENT

STANDARD	
white/brown matt or transparent 4 mm glass	solid chipboard in-fill (third hinge recommended)
version AS4, 03SD standard - tempered glass pane	third hinge in the door leaf (slab) (slab) or adjustable pivot hinge: type B, type D, type K, type C, type M for a width of "60"-80"
white/brown matt 4 mm	concealed DUO type for a width of "60"-80"
single-point mortise lock, spacing: 72 mm (rebated system) or magnetic mortise lock (non-rebated system), key-operated (spacing: 90 mm), for a cylinder (spacing: 85 mm) or a bathroom lock (spacing: 90 mm)	rail and stile set (allowing the user to shorten the door leaf (slab) by max. 50 mm on a do-it-yourself basis)
hinges: type B – for the DIN system door frame, type D – for the wooden or MDF door frame, type M – for the metal door frame or the concealed DUO satin nickel ("60"-80" – 2 pcs, "90" – 3 pcs)	rail and stile set (allowing the user to shorten the door leaf (slab) by max. 90 mm on a do-it-yourself basis)
in case of door leaf (slab) (slab) with door closer and DIN system or metal frame to be used T type hinges ("60"-80" – 3 pcs, "90"-110" – 4 pcs) - replacement of standard hinges with hinge type T for an extra charge	reinforcement for door closer
ADDITIONAL (available at an extra charge)	bottom rail and stile set protection against excessive moisture impact (not applicable to leaves with ventilation trim)
size "100" (glazing decoration as in "90")	door lower by 50 mm or 100 mm (rebated system)
size "110" (glazing decoration as in "90")	door lower by 55 mm or 100 mm (non-rebated system)
REVES system (version A00, C00, F00)	door higher by 50 mm or 100 mm (third hinge in the door leaf (slab) is required) (not applicable to the fixed MDF frame)
recuperation trim	door higher by 150 mm or 200 mm (third hinge in the door leaf (slab) is required) (not applicable to the fixed MDF frame)
perforated chipboard in-fill	ventilation trim (p. 159)
	tempered glass:
	version C, F, 04SD, 05SD
	tempered transparent 4 mm thick glass

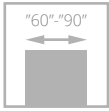

for door leaves with ventilation option

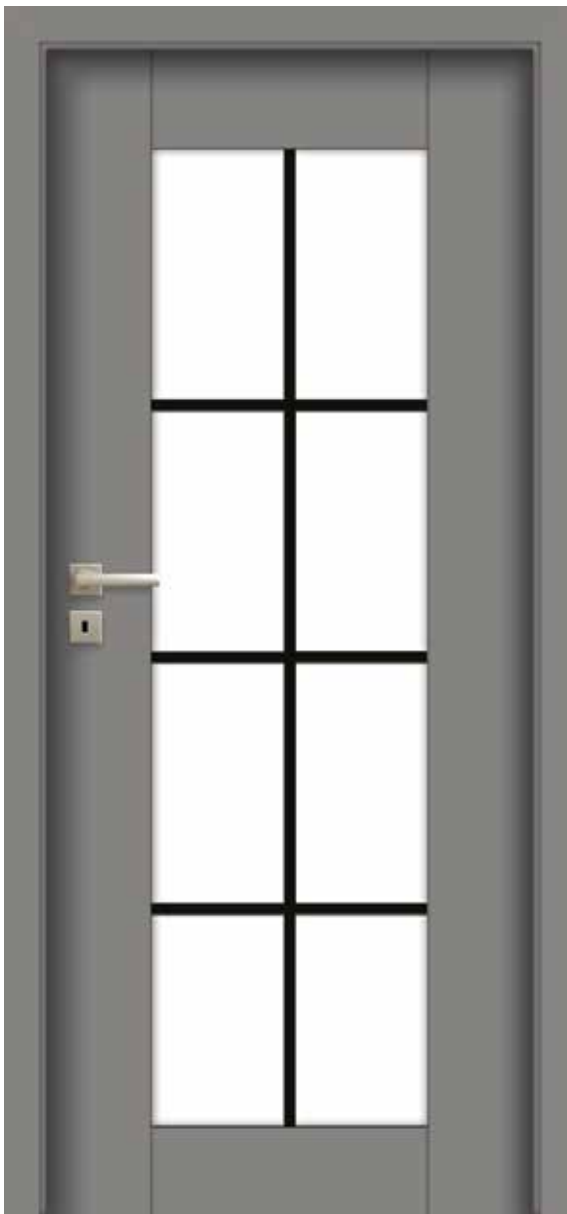

SEDO door, W01S8 version, SYSTEM DIN adjustable door frame

SEDO

NEW VERSIONS

NEW COLOUR



- **constructed with a high quality** MDF rail and stile set
- **large UNI MAT PLUS surface**, characterised by a silky haptics and special coating resistant to fingerprints



muntin bar profile



SEDO door, W01S8 version, SYSTEM DIN adjustable door frame

NEW!
BLACK MUNTIN BARS
AVAILABLE



VERSION **W00 / V01** **W01S8 / V1S8** **W01S8 black muntin bars** **W01 / V1SD** **W02 / V02**



VERSION **W03 / V03** **W04 / V04**

COLOURS

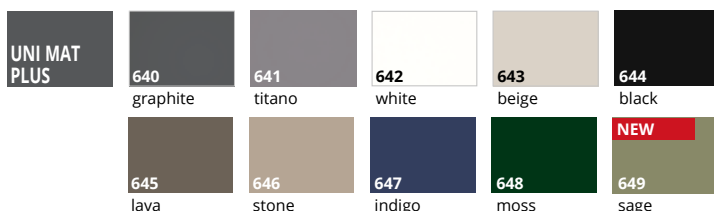

DOOR FRAMES

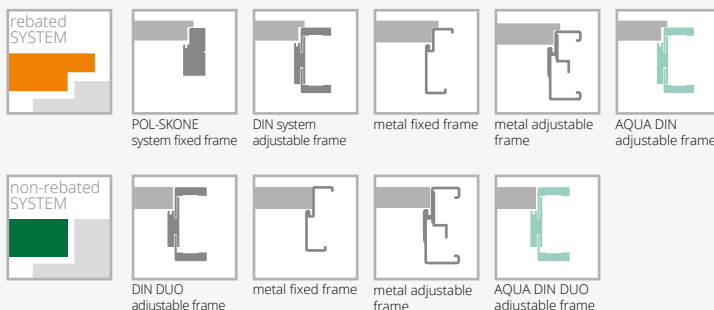

EQUIPMENT

STANDARD
 version W00, W02, W03, W04 panel thickness: 12 mm
 version W01: white matt tempered glass pane, thickness: 4 mm
 version W01, W01S8 transparent or white matt tempered glass pane, thickness: 4 mm
 no possibility to use VSG 22.1, VSG 33.1 laminated glass
 single-point mortise lock, spacing: 72 mm (rebated system) or magnetic mortise lock (non-rebated system), key-operated (spacing: 90 mm), for a cylinder (spacing: 85 mm) or a bathroom lock (spacing: 90 mm)
 644 black, rebated system: lock in the colour of black, hinges in the colour of brushed nickel
 644 black, non-rebated system: lock and hinges in the colour of black
 hinges: type B - for the DIN system door frame, type M - for the metal door frame or the hidden DUO satin nickel ("60"- "90" - 3 pcs)
 644 black: concealed DUO hinge in the colour of black

ADDITIONAL (available at an extra charge)
 recuperation trim (only standard height)
 door lower by 50 mm (rebated system)
 door lower by 55 mm (non-rebated system)
 ventilation trim
 version W01S8: black muntin bars

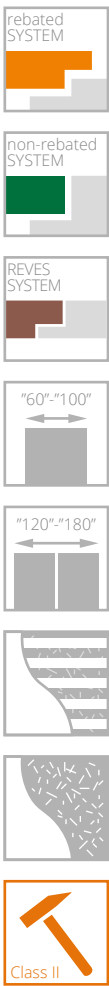

CREATO

**NEW
COLOUR**



- **solid construction – wooden rail and stile set**
- stable perforated **chipboard in-fill**
- **large UNI MAT PLUS surface**, characterised by a silky haptics and special coating resistant to fingerprints
- **VSG 44.2 laminated black or white glass**
- **T type reinforced and DUO type adjustable hinges**



CREATO door, A02 version, SYSTEM DIN adjustable door frame

white hinge – option



CREATO door, A01 version, SYSTEM DIN adjustable door frame



WHITE MATT OR BLACK TRANSPARENT, LAMINATED GLASS

VERSION	A01 / V1SA	A02 / V2SA	A03 / V3SA
---------	-------------------	-------------------	-------------------



WHITE MATT OR GRAPHITE TEMPERED GLASS, THICKNESS 6 MM

VERSION	A01 / V1SA	A02 / V2SA	A03 / V3SA
---------	-------------------	-------------------	-------------------

COLOURS

UNI MAT PLUS	640 graphite	641 titano	642 white	643 beige	644 black
	645 lava	646 stone	647 indigo	648 moss	NEW 649 sage

DOOR FRAMES

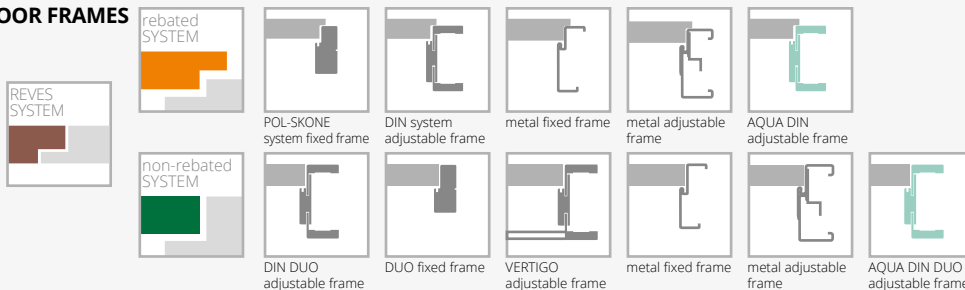

EQUIPMENT

STANDARD
laminated glass 44.2 in the colour of black, transparent or white matt, 8.5 mm thick (glazing width in versions: A01 – 58 mm, A02 – 208 mm, A03 – 280 mm)*
versions with black laminated glass: lock and T and DUO type hinges in the colour of black
versions with white matt and transparent laminated glass: lock and hinges in the colour of silver
single-point mortise lock, spacing: 72 mm (rebated system) or magnetic mortise lock (non-rebated system), key-operated (spacing: 90 mm), for a cylinder (spacing: 85 mm) or a bathroom lock (spacing: 90 mm)
hinges: type T black – for the DIN system or metal door frame, type C, D silver – for the wooden door frame ("60"- "80" – 2 pcs, "90" – 3 pcs) or the concealed DUO, black for the non-rebated system ("60"- "70" – 2 pcs, "80"- "90" – 3 pcs)
door closer is not available
bottom rail and stile set protection against excessive moisture impact is not applicable to
ADDITIONAL (available at an extra charge)
perforated chipboard in-fill (hinge in the door leaf (slab) is required)
size "100"

REVES system
third hinge in the door leaf (slab):
type D for a width of "60"- "80"
type C for a width of "60"- "80"
type T for a width of "60"- "80"
concealed DUO type for a width of "60"- "70"
change of standard type T hinge to the colour of black
change of standard DUO hinge to the colour of black
version A01, A02, A03 door lower by 50 mm (rebated system)
version A01, A02, A03 door lower by 55 mm (non-rebated system)
version A01, A02, A03 door higher by 100 mm (third hinge required at extra charge)
version A01, A02, A03 door higher by 200 mm (third hinge required at extra charge)
leaf (slab) edge in the colour of black (not applicable to REVES system)
sliding system (not applicable to the version A01)
ventilation trim A01 with the "60" - "100" widths
ventilation trim A02, A03 with the "70" - "100" widths

p. 114-119

p. 159

p. 159

*+/- 2 mm tolerance

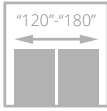
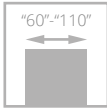

HAPTIC



**NEW
COLOUR**

- **solid construction – wooden rail and stile set**
- **large UNI MAT PLUS surface**, characterised by a silky haptics and special coating resistant to fingerprints
- K and C type adjustable and DUO type concealed hinges

HAPTIC door, 00 version, SYSTEM DIN adjustable door frame



HAPTIC door, 00 version, SYSTEM DIN adjustable door frame

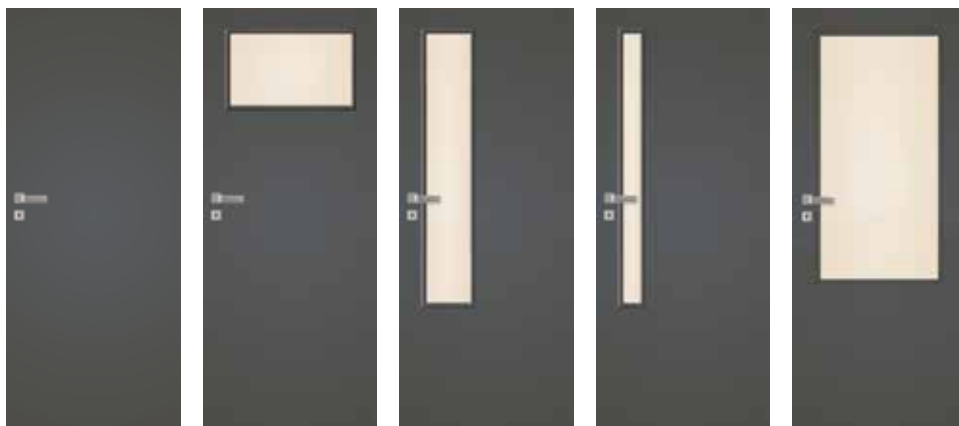

VERSION **00 / V00** **02 / V2S** **04 / V4SD** **05 / V5SD** **03SD / V3SD**

ABS EDGING



COLOURS

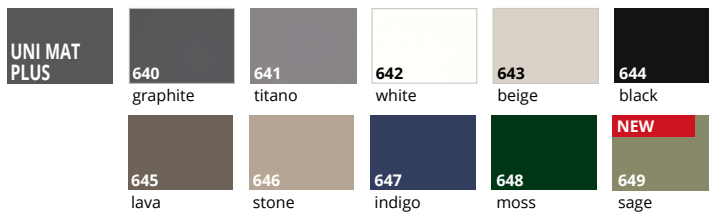

DOOR FRAMES

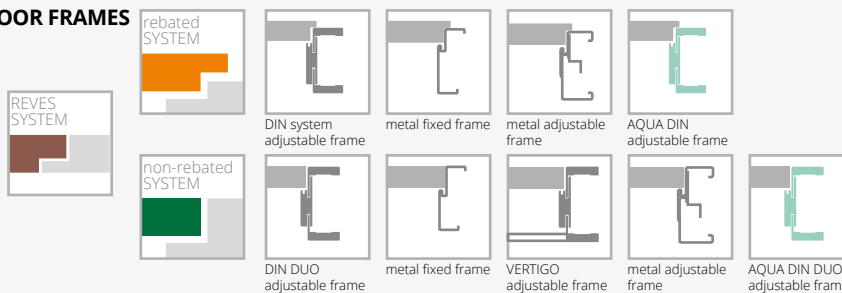

EQUIPMENT

STANDARD
 white/brown matt or transparent 4 mm glass
 model 03SD standard: white/brown tempered glass, thickness: 4 mm
 single-point mortise lock, spacing: 72 mm (rebated system) or magnetic mortise lock (non-rebated system), key-operated (spacing: 90 mm), for a cylinder (spacing: 85 mm) or a bathroom lock (spacing: 90 mm)
 hinges: type K – for the DIN system door frame, type M – for the metal door frame or the concealed DUO satin nickel ("60"-80" – 2 pcs, "90" – 3 pcs)
 in case of door leaf (slab) with door closer and DIN system or metal frame to be used T type hinges ("60"-80" – 3 pcs, "90"-110" – 4 pcs) - replacement of standard hinges with hinge type T for an extra charge

ADDITIONAL (available at an extra charge)
 size "100" (glazing decoration as in "90")
 size "110" (glazing decoration as in "90")
 recuperation trim
 REVES system (version 00)
 perforated chipboard in-fill
 solid chipboard in-fill (third hinge recommended)
 third hinge in the door leaf (slab) or adjustable pivot hinge:
 type K, type M for a width of "60"-80"
 concealed DUO type for a width of "60"-80"

the DUO lock colour replaced with black or golden gloss colour
 rail and stile set (allowing the user to shorten the door leaf (slab) by max. 50 mm on a do-it-yourself basis)
 rail and stile set (allowing the user to shorten the door leaf (slab) by max. 90 mm on a do-it-yourself basis)
 reinforcement for door closer
 bottom rail and stile set protection against excessive moisture impact (not applicable to leaves with ventilation trim)
 door lower by 50 mm or 100 mm (rebated system)
 door lower by 55 mm or 100 mm (non-rebated system)
 door higher by 50 mm or 100 mm (third hinge in the door leaf (slab) is required)
 door higher by 150 mm or 200 mm (third hinge in the door leaf (slab) is required)
 ventilation trim (p. 159)
 tempered glass: version 02, 04, 05
 tempered transparent 4 mm thick glass
 ABS edging in black, white, titano, Polish oak or anthracite (not applicable to REVES system)

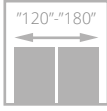
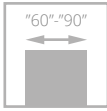

for door leaves with ventilation option



ARIA door, W01 version, SYSTEM DIN adjustable door frame

ARIA

NEW

NEW
COLOUR

COMPOSE YOUR ARIA

choose the **colours**
of the muntins **yourself**

- **constructed with a high quality** MDF rail and stile set
- 30 mm thick glued muntin bars covered with **UNI MAT PLUS or SILKSTONE** surface
- panel thickness: 12 mm
- vertical and horizontal rail and stile set **is the same** 40 mm thickness
- large UNI MAT PLUS surface, characterised by **a silky haptics** and **special coating resistant to fingerprints**



muntin bar



ARIA door, W03 version, SYSTEM DIN adjustable door frame





VERSION **W01/V01** **W01S*/V1SD** **W02/V02** **W02S*/V2SD** **W03/V03** **W03S*/V3SD**

*glassed version



COLOURS

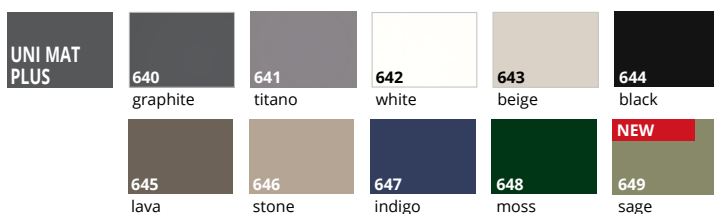

DOOR FRAMES

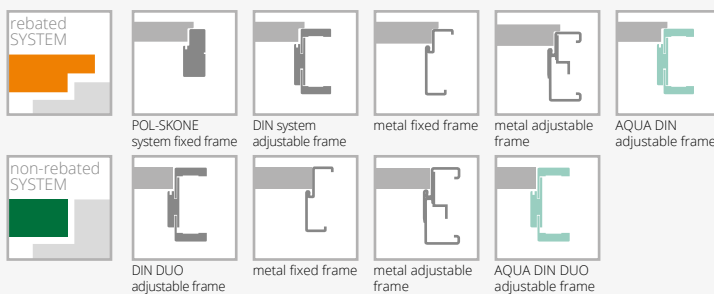

EQUIPMENT

STANDARD	ADDITIONAL (available at an extra charge)
version W01S, W02S, W03S: white matt tempered glass pane, thickness: 4 mm	recuperation trim (only standard height)
solid construction – a high quality MDF rail and stile set	door lower by 50 mm (rebated system)
MDF rail and stile set thickness 12 mm covered with UNI MAT PLUS surface	door lower by 55 mm (non-rebated system)
vertical and horizontal rail and stile set is the same 40 mm thickness	ventilation trim
30 mm thick glued muntin bars covered with UNI MAT PLUS or SILKSTONE surface	tempered transparent 4 mm thick glass
single-point mortise lock in white zinc, 72 mm spacing (rebated system), in UNI MAT PLUS 644 black colour, single-point mortise lock in black colour, 72 mm spacing (rebated system) or magnetic lock in satin nickel colour (non-rebated system) mortise key-operated (90 mm spacing) for a cylinder (85 mm spacing) or for a bathroom lock (90 mm spacing)	
UNI MAT PLUS 644 black colour magnetic lock in black colour (non-rebated system) key-operated (spacing 90 mm) for an insert (spacing 85 mm) or for a bathroom lock (spacing 90 mm)	
silver hinges: type B – for the DIN system door frame, type M – for the metal door frame or the concealed DUO satin nickel colour ("60"-90" – 3 pcs), in UNI MAT PLUS 644 black concealed hinges DUO in black colour	

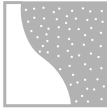
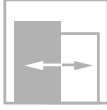
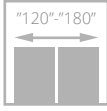
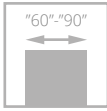

for door leaves with ventilation option



ESTO

NEW

NEW COLOUR

- **solid construction** – a high quality MDF rail and stile set
- 40 mm thick **vertical rail and stile set**
- 35 mm thick **horizontal rail and stile set** (upper and bottom)
- 22 mm thick **panels**

ESTO door, V3S5 version, SYSTEM DIN adjustable door frame



ESTO door, V3S5 version, SYSTEM DIN adjustable door frame



VERSION **V03** **V3S1** **V3S2**



VERSION **V3S3** **V3S4** **V3S5**

COLOURS

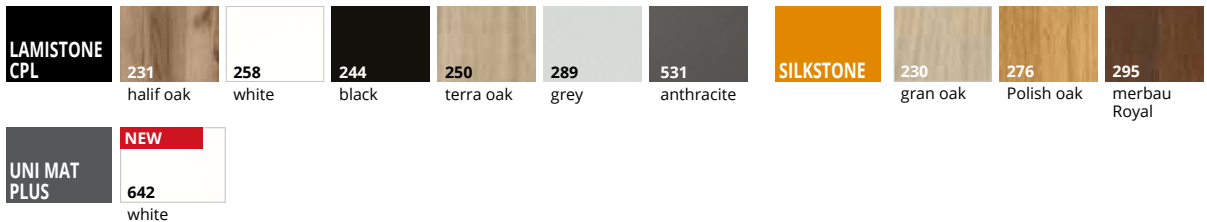

DOOR FRAMES

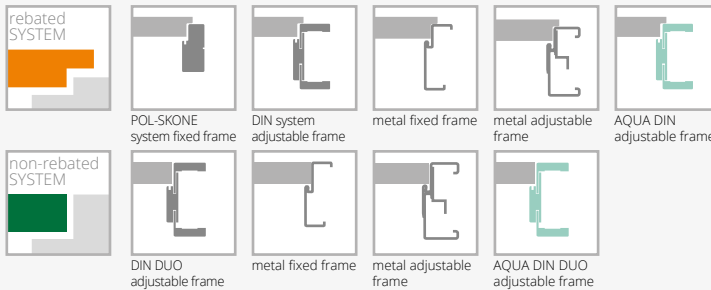

EQUIPMENT

STANDARD	ADDITIONAL (available at an extra charge)
solid construction – a high quality MDF rail and stile set	recuperation trim (only standard height)
40 mm thick vertical rail and stile set	door lower by 50 mm (rebated system)
35 mm thick horizontal rail and stile set (upper and bottom)	door lower by 55 mm (non-rebated system)
22 mm thick panels	ventilation trim
white matt glass 4 mm thick	tempered transparent 4 mm thick glass
single-point mortise lock in white zinc, 72 mm spacing (rebated system), in 244 black colour, single-point mortise lock in black colour, 72 mm spacing (rebated system) or magnetic lock in satin nickel colour (non-rebated system) mortise key-operated (90 mm spacing) for a cylinder (85 mm spacing) or for a bathroom lock (90 mm spacing) in 244 black colour magnetic lock in black colour (non-rebated system) key-operated (spacing 90 mm) for an insert (spacing 85 mm) or for a bathroom lock (spacing 90 mm)	
silver hinges: type B – for the DIN system door frame, type M – for the metal door frame or the concealed DUO satin nickel ("60"- "90" – 3 pcs). in black 244 concealed hinges DUO in black colour	

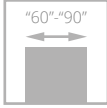

for door leaves with ventilation option



MODO door, W00 version, SYSTEM DIN adjustable door frame

MODO

NEW COLOUR

- **solid construction** – a high quality MDF rail and stile set
- **vertical and horizontal** rail and stile set is the same 40 mm thickness
- MDF rail and stile set covered with **UNI MAT PLUS, LAMISTONE, SILKSTONE surface**
- 12 mm thick MDF panel covered with **UNI MAT PLUS, LAMISTONE, SILKSTONE surface**
- **spatial** design frame



door frame profile



MODO door, W00 version, DIN adjustable door frame



VERSION **W00 / V01** **W01 / V1SD** **W02 / V02** **W03 / V03**

COLOURS

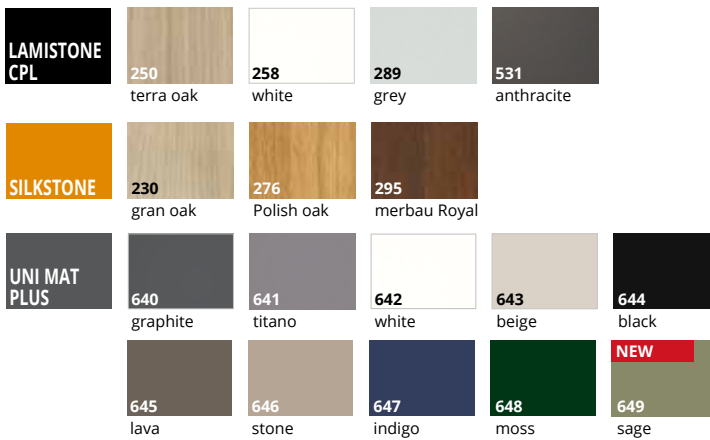

DOOR FRAMES

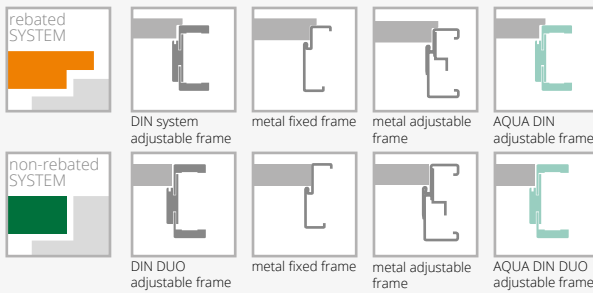

EQUIPMENT

STANDARD	ADDITIONAL (available at an extra charge)
<p>version W01 - white matt tempered glass pane, thickness: 4 mm</p> <p>single-point mortise lock in white zinc, 72 mm spacing (rebated system), in UNI MAT PLUS 644 black colour, single-point mortise lock in black colour, 72 mm spacing (rebated system) or magnetic lock in satin nickel colour (non-rebated system) mortise key-operated (90 mm spacing) for a cylinder (85 mm spacing) or for a bathroom lock (90 mm spacing)</p> <p>UNI MAT PLUS 644 black colour magnetic lock in black colour (non-rebated system) key-operated (spacing 90 mm) for an insert (spacing 85 mm) or for a bathroom lock (spacing 90 mm)</p> <p>hinges: type B – for the DIN system door frame, type M – for the metal door frame or the concealed DUO satin nickel colour ("60"-“90" – 3 pcs) in UNI MAT PLUS 644 black concealed hinges DUO in black colour</p> <p>door closer is not available</p> <p>drop seal is not available</p> <p>no possibility to use VSG 22.1, VSG 33.1 laminated glass</p>	<p>recuperation trim (only standard height)</p> <p>door lower by 50 mm (rebated system)</p> <p>door lower by 55 mm (non-rebated system)</p> <p>ventilation trim</p> <p>tempered transparent 4 mm thick glass</p>

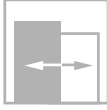
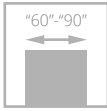

for door leaves with ventilation option



VERI

**NEW
COLOUR**

- **solid construction** – a high quality MDF rail and stile set
- **vertical and horizontal** rail and stile set is the same 40 mm thickness
- MDF rail and stile set covered with **UNI MAT PLUS, LAMISTONE, SILKSTONE surface**
- 12 mm thick MDF panel covered with **UNI MAT PLUS, LAMISTONE, SILKSTONE surface**
- **spatial** design frame



door frame profile



special bevel on the rail and stile joint

VERI door, W02 version, SYSTEM DIN adjustable door frame



VERI door, W00 version, DIN DUO adjustable door frame











VERSION **W00 / V01** **W01 / V1SD** **W02 / V02** **W03 / V03**

COLOURS

LAMISTONE CPL	 250 terra oak	 258 white	 289 grey	 531 anthracite
	 230 gran oak	 276 Polish oak	 295 merbau Royal	
UNI MAT PLUS	 640 graphite	 641 titano	 642 white	 643 beige
	 645 lava	 646 stone	 647 indigo	 648 moss
				 644 black
				 649 sage
				 NEW 649 sage

DOOR FRAMES

rebated SYSTEM	 DIN system adjustable frame	 metal fixed frame	 metal adjustable frame	 AQUA DIN adjustable frame
	 DIN DUO adjustable frame	 metal fixed frame	 metal adjustable frame	 AQUA DIN DUO adjustable frame

EQUIPMENT

STANDARD

version W01 - white matt tempered glass pane, thickness: 4 mm

mortise single point lock in white zinc, 72 mm spacing (rebated system), in colour UNI MAT PLUS black 644 mortise single point lock in black 72 mm spacing (rebated system) or magnetic lock in satin nickel (non-rebated system) key-operated (90 mm spacing) for a cylinder (85 mm spacing) or for a bathroom lock (90 mm spacing) in colour UNI MAT PLUS black 644 magnetic lock in black (non-rebated system) key-operated (spacing 90 mm) for a cylinder (spacing 85 mm) or for a bathroom lock (spacing 90 mm)

hinges: type B - for the DIN system door frame, type M - for the metal door frame or the concealed DUO satin nickel ("60"-/90" - 3 pcs)

In black UNI MAT PLUS 644 concealed hinges DUO in black.

door closer is not available

drop seal is not available

no possibility to use VSG 22.1, VSG 33.1 laminated glass

ADDITIONAL (available at an extra charge)

recuperation trim (only standard height)

door lower by 50 mm (rebated system)

door lower by 55 mm (non-rebated system)

ventilation trim

tempered transparent 4 mm thick glass

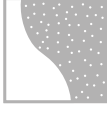
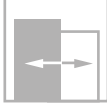
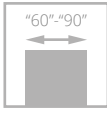

for door leaves with ventilation option



EGRO door, W00 version, SYSTEM DIN adjustable door frame

EGRO

NEW COLOUR

- **solid construction** – a high quality MDF rail and stile set
- **vertical and horizontal** rail and stile set is the same 40 mm thickness
- MDF rail and stile set covered with **UNI MAT PLUS, LAMISTONE, SILKSTONE surface**
- 16 mm thick MDF panel covered with **UNI MAT PLUS, LAMISTONE, SILKSTONE surface**
- 16 mm thick **spatial** design frame



spatial design frame



EGRO door, W00 version, DIN adjustable door frame



VERSION **W00 / V01** **W01 / V1SD** **W02 / V02** **W03 / V2SD** **W04 / V03** **W05 / V3SD**

COLOURS

LAMISTONE CPL				
	250 terra oak	258 white	289 grey	531 anthracite
SILKSTONE				
	230 gran oak	276 Polish oak	295 merbau Royal	
UNI MAT PLUS	640 graphite	641 titano	642 white	643 beige
	645 lava	646 stone	647 indigo	648 moss
	644 black			NEW 649 sage

DOOR FRAMES

rebated SYSTEM					
	DIN system adjustable frame	metal fixed frame	metal adjustable frame	AQUA DIN adjustable frame	
	non-rebated SYSTEM				
		DIN DUO adjustable frame	metal fixed frame	metal adjustable frame	AQUA DIN DUO adjustable frame

EQUIPMENT

STANDARD	ADDITIONAL (available at an extra charge)
version W01, W03, W05 - white matt tempered glass pane, thickness: 4 mm	recuperation trim (only standard height)
version W00, W02, W04 - spatial design frame thickness 16 mm	door lower by 50 mm (rebated system)
mortise single point lock in white zinc, 72 mm spacing (rebated system), in colour UNI MAT PLUS black 644 single point mortise lock in black 72 mm spacing (rebated system) or magnetic lock in satin nickel (non-rebated system) key-operated (90 mm spacing) for a cylinder (85 mm spacing) or for a bathroom lock (90 mm spacing)	door lower by 55 mm (non-rebated system)
in colour UNI MAT PLUS black 644 magnetic lock in black (non-rebated system) key-operated (spacing 90 mm) for a cylinder (spacing 85 mm) or for a bathroom lock (spacing 90 mm)	ventilation trim
hinges: type B – for the DIN system door frame, type M – for the metal door frame or the concealed DUO satin nickel ("60"-/90" – 3 pcs)	tempered transparent 4 mm thick glass
In black UNI MAT PLUS 644 concealed hinges DUO in black.	
door closer is not available	
drop seal is not available	
no possibility to use VSG 22.1, VSG 33.1 laminated glass	

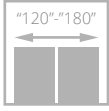
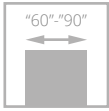

for door leaves with ventilation option



FIORI

- constructed with a high quality MDF rail and stile set
- vertical and horizontal rail and stile set is the same 40 mm thickness



special bevel on the rail and stile joint



available at an extra charge: **VSG 22.1 laminated glass in the colour of black**

FIORI door, W02S2P version, SYSTEM DIN adjustable door frame



FIORI door, W02 version, DIN adjustable door frame



VERSION **W02 / V4S4** **W02P / V04** **W02S2P / V4S2**

COLOURS

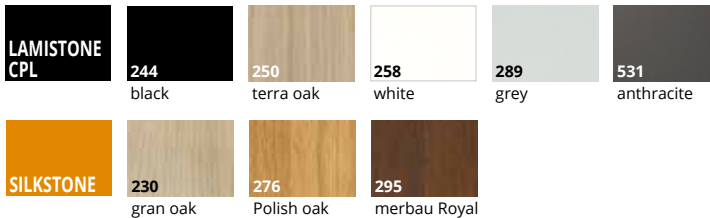

DOOR FRAMES

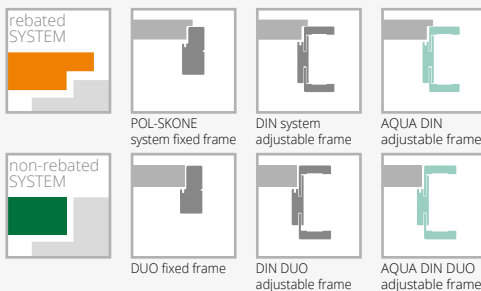

EQUIPMENT

STANDARD	ADDITIONAL (available at an extra charge)
white/brown matt or transparent 4 mm glass	recuperation trim (only standard height)
single-point mortise lock, spacing: 72 mm (rebated system) or magnetic mortise lock (non-rebated system), key-operated (spacing: 90 mm), for a cylinder (spacing: 85 mm) or a bathroom lock (spacing: 90 mm)	black-coloured lock rebated system
hinges: type B – for the DIN system door frame, type D – for the wooden door frame or the concealed DUO satin nickel ("60"-"90" – 3 pcs)	the DUO hinge replaced with white or black colour
door closer is not available	door lower by 50 mm (rebated system)
drop seal is not available	door lower by 55 mm (non-rebated system)
	ventilation trim (p. 159)
	VSG 22.1 laminated glass in the colour of black (applicable to 1 glass pane): version W02, W02S2P
	VSG 22.1 laminated white or transparent glass (applicable to 1 glass pane)
	tempered transparent 4 mm thick glass
	the DUO lock colour replaced with golden gloss colour

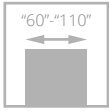

IMPULS



- **solid construction – wooden rail and stile set**
- door available in **10 working days** under the “fast delivery” promotion
- **large LAMISTONE CPL and SILKSTONE** surface finish
- K and C type adjustable and DUO type concealed hinges



IMPULS door, W06 version, SYSTEM DIN adjustable door frame

spacer frame profile

door frame



IMPULS door, W13 version (door on the left side), W01 version (door on the right side), SYSTEM DIN adjustable door frame



VERSION **W01 / V00** **W02 / V2S** **W03 / V3SD** **W05 / V1SD** **W06 / V4SD** **W07 / V5SD** **W12D1 / V6S1** **W12 / V6S4** **W13 / V1SA** **W14 / V1SA**

COLOURS



DOOR FRAMES

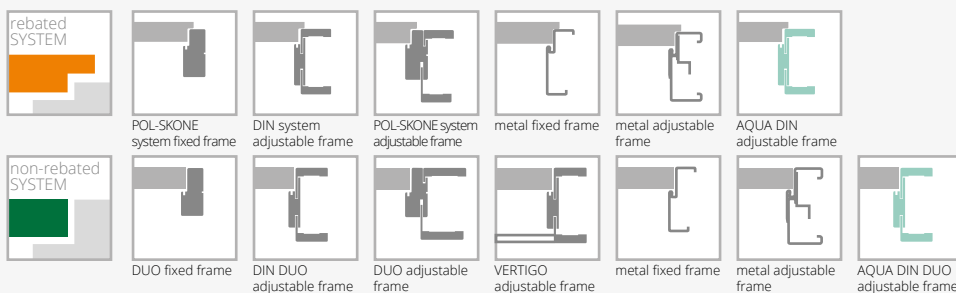

EQUIPMENT

STANDARD

white/brown matt or transparent 4 mm glass
white/brown matt tempered glass version W03, W05
version W13: white/brown matt tempered glass, thickness: 6 mm
version W14: laminated glass 44.2 in the colour of black, 8.5 mm thick
single-point mortise lock, spacing: 72 mm (rebated system) or magnetic mortise lock (non-rebated system), key-operated (spacing: 90 mm), for a cylinder (spacing: 85 mm) or a bathroom lock (spacing: 90 mm)
hinges: type K – for the DIN system door frame, type C - for the wooden door frame, type M – for the metal door frame or the concealed DUO satin nickel ("60"-80" – 2 pcs, "90" – 3 pcs)
in case of door leaf (slab) with door closer and DIN system or metal frame to be used T type hinges ("60"-80" – 3 pcs, "90"-110" – 4 pcs) - replacement of standard hinges with hinge type T for an extra charge

ADDITIONAL (available at an extra charge)

size "100" (glazing decoration as in "90")
size "110" (glazing decoration as in "90")
REVES system (version W01, W13, W14)
recuperation trim (not applicable to version W13, W14)
perforated chipboard in-fill
solid chipboard in-fill (third hinge recommended)
third hinge in the door leaf (slab) or adjustable pivot hinge:
type K, type C, type M for a width of "60"-80"
concealed DUO type for a width of "60"-80"
the DUO lock colour replaced with black or golden gloss colour
rail and stile set (allowing the user to shorten the door leaf (slab) by max. 50 mm on a do-it-yourself basis) (not applicable to version W13, W14)

rail and stile set (allowing the user to shorten the door leaf (slab) by max. 90 mm on a do-it-yourself basis) (not applicable to version W13, W14)
reinforcement for door closer (not applicable to version W13, W14)
bottom rail and stile set protection against excessive moisture impact (not applicable to leaves with ventilation trim) (not applicable to version W13, W14)
door lower by 50 mm or 100 mm (rebated system) (not applicable to version W13, W14)
door lower by 55 mm or 100 mm (non-rebated system) (not applicable to version W13, W14)
door higher by 50 mm or 100 mm (not applicable to version W13, W14) (third hinge in the door leaf (slab) is required)
door higher by 150 mm or 200 mm (not applicable to version W13, W14) (third hinge in the door leaf (slab) is required)
version W13, W14 door lower 1970 mm (rebated system), 1985 mm (non-rebated system)
version W13, W14 door higher by 100 mm (third hinge in the door leaf (slab) is required)
version W13, W14 door higher by 200 mm (third hinge in the door leaf (slab) is required)
ventilation trim (p. 159)
tempered glass:
version W02, W06, W07, W12D1, W12
sliding system (not applicable to version W13, W14) p. 114-119
tempered transparent 4 mm thick glass
ABS edging in black, white, titano, polish oak or anthracite (not applicable to REVES system)



ETIUDA

- **solid construction – wooden rail and stile set**
- **large LAMISTONE CPL and SILKSTONE** surface finish
- white matt and graphite **tempered glass**, thickness: 6 mm
- aluminium decorative strips in the colour of silver or black
- K and C type adjustable and DUO type concealed hinges



aluminium decorative strips



option: aluminium glazing strips in the colour of black



option: aluminium decorative strips in the colour of black

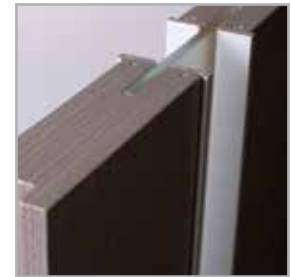

top door leaf (slab) edge without a rebate

ETIUDA door, B1 version, SYSTEM DIN adjustable door frame



ETIUDA door, B1 version (door on the left side), A01 version (door on the right side), POL-SKONE system fixed door frame

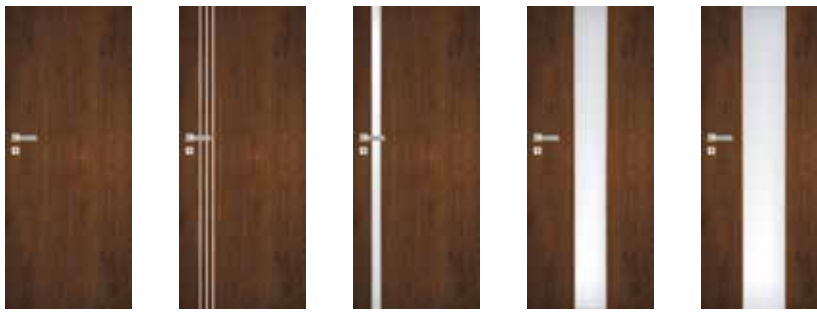

VERSION **B0 / V00** **B1 / VD11** **A01 / V1SA** **A02 / V2SA** **A03 / V3SA**

COLOURS



DOOR FRAMES

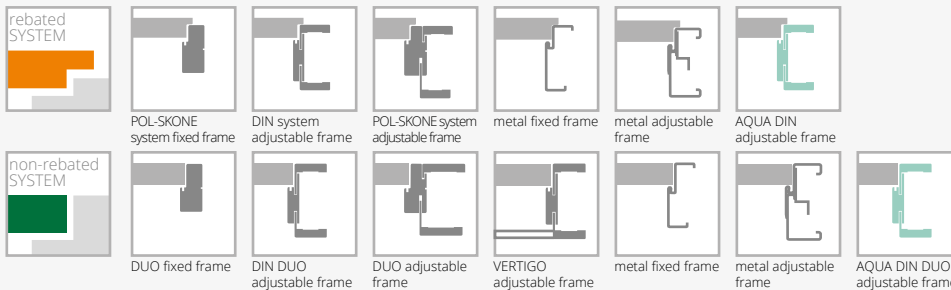

EQUIPMENT

STANDARD

white/brown matt tempered glass, thickness: 6 mm

black-coloured glass pane is not available

glazing width in the A01 version – 54 mm; A02 – 205 mm, A03 – 276 mm*

single-point mortise lock, spacing: 72 mm (rebated system) or magnetic mortise lock (non-rebated system), key-operated (spacing: 90 mm), for a cylinder (spacing: 85 mm) or a bathroom lock (spacing: 90 mm)

hinges: type K – for the DIN system door frame, type C – for the wooden door frame, type M – for the metal door frame or the concealed DUO satin nickel ("60"- "80" – 2 pcs, "90" – 3 pcs)

in case of door leaf (slab) with door closer and DIN system or metal frame to be used T type hinges ("60"- "80" – 3 pcs, "90"- "110" – 4 pcs) - replacement of standard hinges with hinge type T for an extra charge

ADDITIONAL (available at an extra charge)

size "100"

size "110" (applicable to the version B0, B1)

perforated chipboard in-fill (versions B0, A01, A02, A03)

solid chipboard in-fill (versions B0, A01, A02, A03) (third hinge recommended)

third hinge in the door leaf (slab) or adjustable pivot hinge: type K, type C, type M for a width of "60"- "80" concealed DUO type for a width of "60"- "80"

the DUO lock colour replaced with black or golden gloss colour

rail and stile set (allowing the user to shorten the door leaf (slab) by max. 50 mm on a do-it-yourself basis) (applicable to versions B0)

rail and stile set (allowing the user to shorten the door leaf (slab) by max. 90 mm on a do-it-yourself basis) (applicable to versions B0)

*+/- 2 mm tolerance

reinforcement for door closer (not applicable to the version A01, A02, A03)

bottom rail and stile set protection against excessive moisture impact (not applicable to leaves with ventilation trim) (not applicable to versions A01, A02, A03)

door lower by 50 mm or 100 mm (rebated system) (not applicable to versions A01, A02, A03)

door lower by 55 mm or 100 mm (non-rebated system) (not applicable to versions A01, A02, A03)

door higher by 50 mm or 100 mm (not applicable to versions A01, A02, A03) (third hinge in the door leaf (slab) is required)

door higher by 150 mm or 200 mm (not applicable to versions A01, A02, A03) (third hinge in the door leaf (slab) is required)

version A01, A02, A03 door lower by 50 mm (rebated system)

version A01, A02, A03 door lower by 55 mm (non-rebated system)

version A01, A02, A03 door higher by 100 mm (third hinge in the door leaf (slab) is required)

version A01, A02, A03 door higher by 200 mm (third hinge in the door leaf (slab) is required)

ventilation trim (applicable to versions B0, B1) (p. 159)

ventilation trim A01 with the "60" - "100" widths (p. 159)

ventilation trim A02, A03 with the "70" - "100" widths (p. 159)

tempered 6 mm glass in the colour of graphite or transparent

change of colour of decorative strips to black:

version B1

version A01-A03

sliding system (not applicable to version A01)

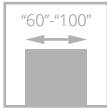

SONATA door, W4 version, SYSTEM DIN adjustable door frame

SONATA

NEW COLOUR



- solid construction – wooden rail and stile set
- stable perforated chipboard in-fill
- large LAMISTONE CPL and SILKSTONE surface finish
- K and C type adjustable and DUO type concealed hinges



aluminium decors on the leaf (slab) surface in the colour of matt chrome (standard)



VERTIGO door frame, upper panel



aluminium decors on the leaf (slab) surface in the colour of black, golden gloss, chrome gloss (option) – p. 163



leaf (slab) laminated edge in the colour of black, graphite or grey – option (not applicable to the BLACK surface)



SONATA door, W2 version, VERTIGO adjustable door frame



VERSION **W1 / VD1** **W2 / VD2** **W4 / VD4** **W5 / VD5** **W6 / VD6** **W7 / VD7** **W8 / VD8**

COLOURS

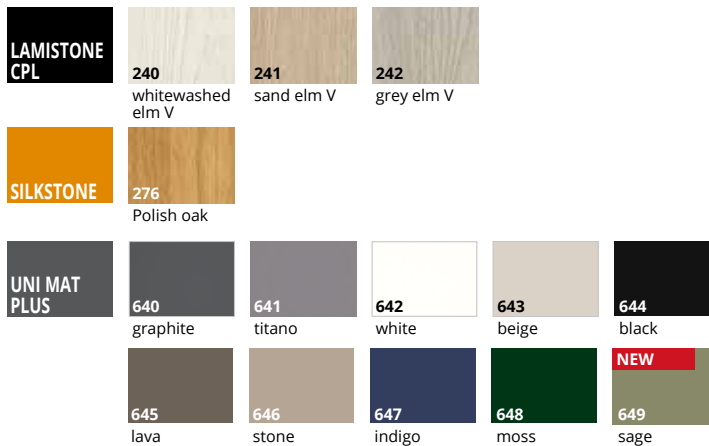

DOOR FRAMES

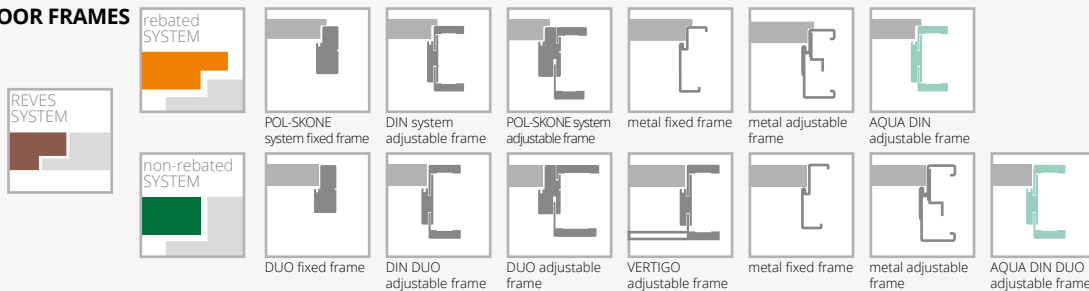

EQUIPMENT

STANDARD	
single-point mortise lock, spacing: 72 mm (rebated system) or magnetic mortise lock (non-rebated system), key-operated (spacing: 90 mm), for a cylinder (spacing: 85 mm) or a bathroom lock (spacing: 90 mm)	rail and stile set (allowing the user to shorten the door leaf (slab) by max. 50 mm on a do-it-yourself basis) (not applicable to version W8)
hinges: type K - for the DIN system door frame, type C - for the wooden door frame, type M - for the metal door frame ("60"-80" - 2 pcs, "90" - 3 pcs) or the concealed DUO satin nickel ("60"-70" - 2 pcs, "80"-90" - 3 pcs)	rail and stile set (allowing the user to shorten the door leaf (slab) by max. 90 mm on a do-it-yourself basis) (not applicable to version W8)
in case of door leaf (slab) with door closer and DIN system or metal frame to be used T type hinges ("60"-80" - 3 pcs, "90"-100" - 4 pcs) - replacement of standard hinges with hinge type T for an extra charge	reinforcement for door closer
version W8: no possibility to use a ventilation slot or a ventilation grill	bottom rail and stile set protection against excessive moisture impact (not applicable to leaves with ventilation trim)
ADDITIONAL (available at an extra charge)	door lower by 50 mm or 100 mm (rebated system)
size "100"	door lower by 55 mm or 100 mm (non-rebated system)
REVES system	door higher by 50 mm or 100 mm (third hinge in the door leaf (slab) is required)
perforated chipboard in-fill (hinge in the door leaf (slab) is required)	door higher by 150 mm or 200 mm (third hinge in the door leaf (slab) is required)
recuperation trim	ventilation trim (p. 159)
third hinge in the door leaf (slab): type K, type C, type M for a width of "60"-80"	aluminium edge (non-rebated system)
concealed DUO type for a width of "60"-70"	aluminium decors in black, chrome gloss, golden gloss
	leaf (slab) edge in the colour of black, grey or graphite (not applicable to REVES system)

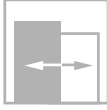
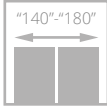
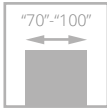

for door leaves with ventilation option



FORTIMO

NEW COLOUR

- solid construction – wooden rail and stile set
- large LAMISTONE CPL and SILKSTONE surface finish
- leaf (slab) stiles - vertical wood grain; panel – vertical wood grain
- white matt, brown matt, graphite or transparent tempered glass, thickness: 4 mm



glazing

FORTIMO door, W01S1 version, SYSTEM DIN adjustable door frame



FORTIMO door, W01S1 version, SYSTEM DIN adjustable door frame



VERSION **W01 / V01**

W01S1 / V1S

W03 / V02

W03S1 / V2S

COLOURS



DOOR FRAMES

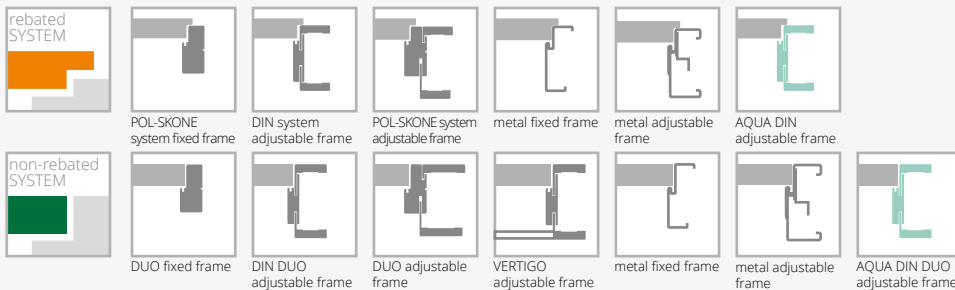

EQUIPMENT

STANDARD	ADDITIONAL (available at an extra charge)
white matt tempered glass, thickness: 4 mm	size "100"
single-point mortise lock, spacing: 72 mm (rebated system) or magnetic mortise lock (non-rebated system), key-operated (spacing: 90 mm), for a cylinder (spacing: 85 mm) or a bathroom lock (spacing: 90 mm)	recuperation trim (only standard height)
hinges: type K - for the DIN system door frame, type C - for the wooden door frame, type M - for the metal door frame or the concealed DUO satin nickel ("70"- "80" - 2 pcs, "90" - 3 pcs)	size "60" (applicable to W01, W01S1)
door closer is not available	third hinge in the door leaf (slab): type K, type C, type M for a width of "70"- "80" concealed DUO type for a width of "70"- "80"
	door lower by 50 mm (rebated system)
	door lower by 55 mm (non-rebated system)
	ventilation trim (p. 159)
	VSG 22.1 laminated matt or transparent glass
	VSG 22.1 laminated black glass
	brown/graphite or transparent tempered 4 mm thick glass

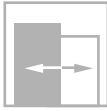
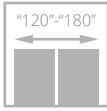
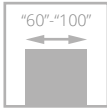

INVERNO

**NEW
COLOUR**

- **solid construction – wooden rail and stile set**
- stable solid **chipboard in-fill**
- **large LAMISTONE CPL, SILKSTONE and UNI MAT PLUS** surface finish
- K and C type adjustable and DUO type concealed hinges



INVERNO door, 01 version, SYSTEM DIN adjustable door frame

strip profile



INVERNO door, 00 version, SYSTEM DIN adjustable door frame



VERSION 00 / V01

OSD / V1SD

01 / V02

01SD / V2SD

COLOURS

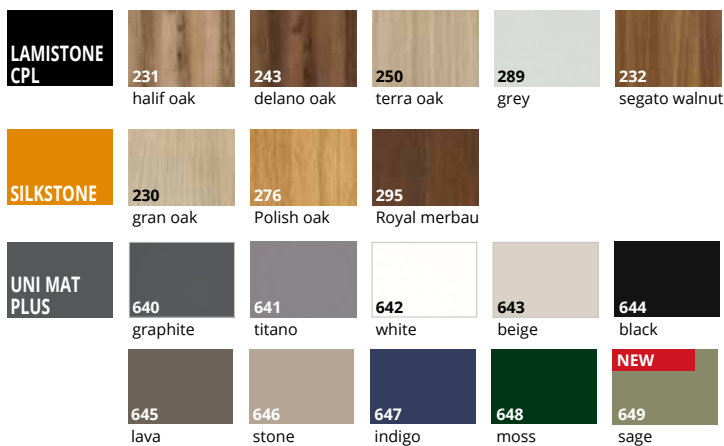

DOOR FRAMES

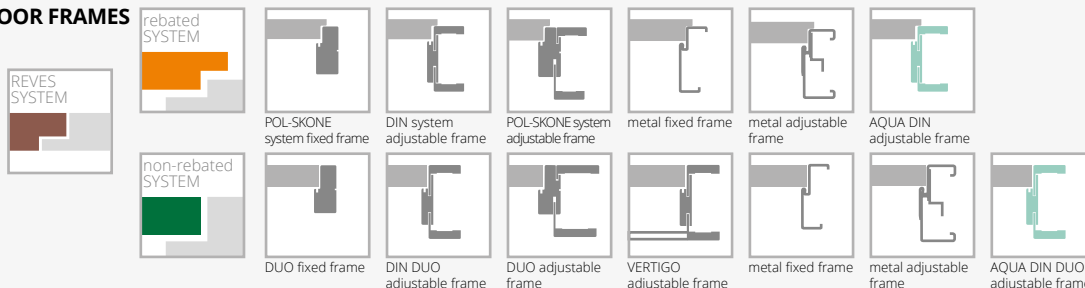

EQUIPMENT

STANDARD	ADDITIONAL (available at an extra charge)
versions OSD, 01SD: white matt tempered glass, thickness: 4 mm	size "100" (glazing decoration as in "90")
single-point mortise lock, spacing: 72 mm (rebated system) or magnetic mortise lock (non-rebated system), key-operated (spacing: 90 mm), for a cylinder (spacing: 85 mm) or a bathroom lock (spacing: 90 mm)	REVES system (version 00, 01) (the door opening angle is 88° above ZW4 range)
hinges: type K – for the DIN system door frame, type C – for the wooden door frame, type M – for the metal door frame or the concealed DUO satin nickel ("60"- "80" – 2 pcs, "90" – 3 pcs)	recuperation trim
in case of door leaf (slab) with door closer and DIN system or metal frame to be used T type hinges ("60"- "80" – 3 pcs, "90"- "100" – 4 pcs) - replacement of standard hinges with hinge type T for an extra charge	third hinge in the door leaf (slab): type K, type C, type M for a width of "60"- "80" concealed DUO type for a width of "60"- "80"
rebated system, 244, 644 black colour: hinges in the colour of silver, lock in the colour of black	change of standard DUO hinge to the colour of white or black
non-rebated system, 244, 644 black colour: hinges and lock in the colour of black	reinforcement for door closer
transparent pane cannot be used	bottom rail and stile set protection against excessive moisture impact (not applicable to leaves with ventilation trim)
	door lower by 50 mm or 100 mm (rebated system)
	door lower by 55 mm or 100 mm (non-rebated system)
	door higher by 50 mm or 100 mm (third hinge in the door leaf (slab) is required)
	door higher by 150 mm or 200 mm (third hinge in the door leaf (slab) is required)
	ventilation trim (p. 159)

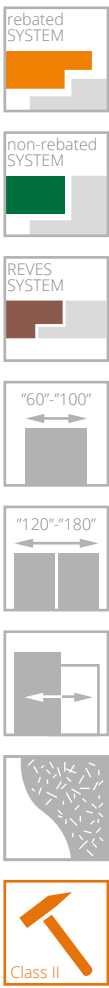

NOSTRE



- **solid construction – wooden rail and stile set**
- stable solid **chipboard in-fill**
- **large LAMISTONE CPL and SILKSTONE** surface finish
- K and C type adjustable and DUO type concealed hinges



NOSTRE door, 03 version, SYSTEM DIN adjustable door frame

NOSTRE door leaf (slab) decorative strip



NOSTRE door, 03 version, SYSTEM DIN adjustable door frame



VERSION 00 / V01 OSD / V1SD 01 / V02 01SM / V2SM 01SD / V2SD



VERSION 02 / V03 02S1 / V3S1 02S3 / V3S3 03 / V04 03SD / V4SD

COLOURS



DOOR FRAMES

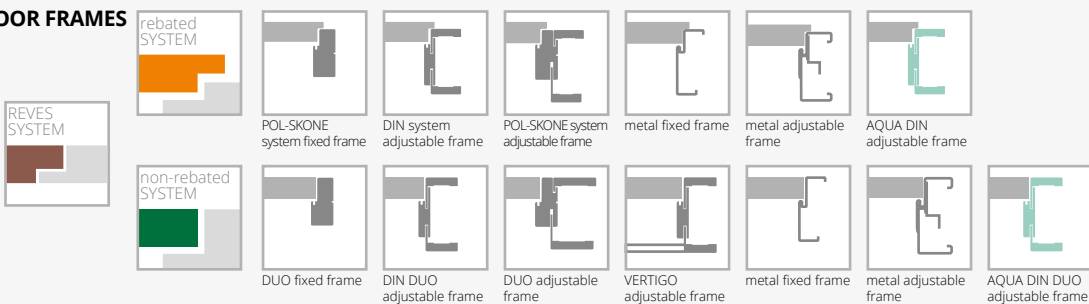

EQUIPMENT

STANDARD
 white matt glass, thickness: 4 mm
 pattern OSD, 01SD, 03SD tempered glass pane white matt, thickness: 4 mm
 single-point mortise lock, spacing: 72 mm (rebated system) or magnetic mortise lock (non-rebated system), key-operated (spacing: 90 mm), for a cylinder (spacing: 85 mm) or a bathroom lock (spacing: 90 mm)
 hinges: type K – for the DIN system door frame, type C – for the wooden door frame, type M – for the metal door frame ("60"-80" – 2 pcs, "90" – 3 pcs) or the concealed DUO satin nickel ("60"-70" – 2 pcs, "80" – 90" – 3 pcs)
 in case of door leaf (slab) with door closer and DIN system or metal frame to be used T type hinges ("60"-80" – 3 pcs, "90"-100" – 4 pcs) - replacement of standard hinges with hinge type T for an extra charge
ADDITIONAL (available at an extra charge)
 size "100" (glazing decoration as in "90")
 REVES system (version 00, 01, 02, 03)
 (the door opening angle is 88° above ZW4 range)

third hinge in the door leaf (slab): type K, type C, type M for a width of "60"-80"
 concealed DUO type for a width of "60"-80"
 recuperation trim
 reinforcement for door closer
 bottom rail and stile set protection against excessive moisture impact (not applicable to leaves with ventilation trim)
 door lower by 50 mm or 100 mm (rebated system)
 door lower by 55 mm or 100 mm (non-rebated system)
 door higher by 50 mm or 100 mm (third hinge in the door leaf (slab) is required)
 door higher by 150 mm or 200 mm (third hinge in the door leaf (slab) is required)
 ventilation trim (p. 159)

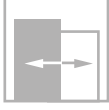

for door leaves with ventilation option

MONA



MONA door, W02 version, SYSTEM DIN DUO adjustable door frame

- solid construction – wooden rail and stile set
- large LAMISTONE CPL surface finish
- cross rail with vertical woodgrain, black colour panel (W01, W02 version), black laminated glass (W01S1, W02S2 version)
- VSG 22.1 laminated non-transparent black glass



black matt panel



black pane



MONA door, W02 version, SYSTEM DIN DUO adjustable door frame



VERSION **W01** / V01 with black panel **W02** / V02 with black panel **W01S1** / V1S with black pane **W02S2** / V2S with black pane

COLOURS



DOOR FRAMES

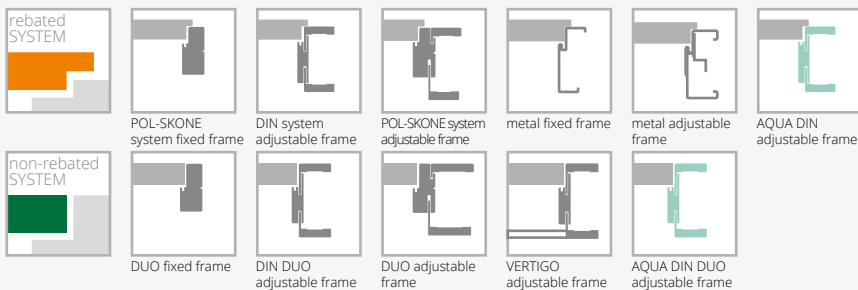

EQUIPMENT

STANDARD	ADDITIONAL (available at an extra charge)
VSG 22.1 laminated non-transparent black 4.2 mm thick glass	size "100"
single-point mortise lock, spacing: 72 mm (rebated system) or magnetic mortise lock (non-rebated system), key-operated (spacing: 90 mm), for a cylinder (spacing: 85 mm) or a bathroom lock (spacing: 90 mm)	recuperation trim (only standard height)
hinges: type K – for the DIN system door frame, type C – for the wooden door frame, type M – for the metal door frame or the concealed DUO satin nickel ("60"- "80" – 2 pcs, "90" – 3 pcs)	size "60" and "60" + "60" (applicable to W01, W01S1)
	third hinge in the door leaf (slab): type K, type C, type M for a width of "70"- "80" silver or black concealed DUO type for a width of "70"- "80"
	door lower by 50 mm (rebated system)
	door lower by 55 mm (non-rebated system)
	ventilation trim p. 159
	sliding system p. 114-119

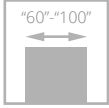

for door leaves with ventilation option



SEMPRE door, W02 version, SYSTEM DIN adjustable door frame

SEMPRE



- **solid construction – wooden rail and stile set**
- **large LAMISTONE CPL and SILKSTONE** surface finish
- leaves available with a **one-sided magnetic board (Z/AZ)** and a **one-sided mirror (WL Z, WL A/Z)**
- K and C type adjustable and DUO type concealed hinges
- door available in **10 working days** under the “fast delivery” promotion



glazing



available at an extra charge: VSG 22.1 laminated glass in the colour of black



SEMPRE door, W02 version (door on the left side), SYSTEM DIN adjustable door frame, W02A version (door on the right side), POL-SKONE fixed door frame



VERSION **W00 / V01** **W01 / V1SD** **W04 / V4SM** **W05 / V4SD** board* Z A/Z mirror* WLZ WLA/Z **W02P / V02** **W02 / V2S5** **W02S1 / V2S1** **W02S2 / V2S2**



VERSION **W02S3 / V2S3** **W02S4 / V2S4** **W02A / V2SA** **W03P / V03** **W03 / V3S5** **W03S1 / V3S1** **W03S2 / V3S2** **W03S3 / V3S3** **W03S4 / V3S4** **W03A / V3SA**



VERSION **W06 / V05** **W07 / V06** **W05 VERSE / V6SD**

* Z, WLZ - board/mirror on the hinge side, A/Z, WLA/Z - board/mirror on the side opposite to the hinge side

COLOURS



DOOR FRAMES

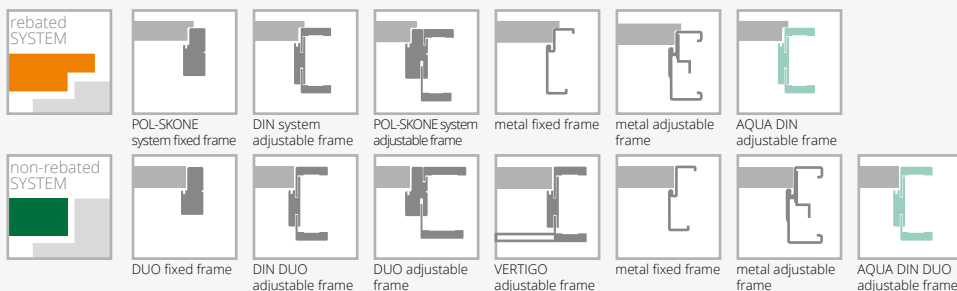

EQUIPMENT

STANDARD
white/brown/graphite or transparent 4 mm glass
version W01, W05 tempered glass 4 mm
version W00, W06, W07, panel thickness: 12 mm
single-point mortise lock, spacing: 72 mm (rebated system) or magnetic mortise lock (non-rebated system), key-operated (spacing: 90 mm), for a cylinder (spacing: 85 mm) or a bathroom lock (spacing: 90 mm)
hinges: type K satin nickel - for the DIN system door frame, type C satin nickel - for the wooden door frame, type M - for the metal door frame or the concealed DUO satin nickel ("60"- "80" - 2 pcs, "90" - 3 pcs)
door closer is not available
drop seal is not available
version W05 VERSE - applicable to "70" - "100" width
ADDITIONAL (available at an extra charge)
size "100"

recuperation trim (only standard height)
third hinge in the door leaf (slab): type K, type C, type M for a width of "60"- "80" concealed DUO type for a width of "60"- "70"
door lower by 50 mm (rebated system) (not applicable to WLZ, WLA/Z)
door lower by 55 mm (non-rebated system) (not applicable to WLZ, WLA/Z)
door higher by 50 mm or 100 mm (not applicable to WLZ, WLA/Z, W05 VERSE) (third hinge in the door leaf (slab) is required)
ventilation trim (p. 159)
VSG 22.1 laminated black glass: version W02, W03
tempered transparent 4 mm thick glass

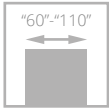

DECO



- solid construction – wooden rail and stile set
- surface is covered with a 0.2 mm, 0.5 mm or 0.7 mm thick CPL laminate, which is resistant to abrasion and chemicals
- door available also in III mechanical class
- K and C type adjustable and DUO type concealed hinges



spacer frame



glazing

DECO door, 00 version, SYSTEM DIN adjustable door frame



DECO door, 05 version, SYSTEM DIN adjustable door frame



VERSION **00 / V00** **02 / V2S** **03SD / V3SD** **04 / V4SD** **05 / V5SD**

To obtain mechanical class III, you need to order the door leaf (slab) with a metal door frame, a wooden door frame or an adjustable DIN mechanical class III frame.

DIN system door frame in III mechanical class, contains reinforcement under the catch plate in the form of a pine bar. Angular catch plate at extra charge added to the adjustable DIN system door frame price.

COLOURS

SILKSTONE CPL 0,5 mm											
LAMINATED CPL 0,2 mm											
LAMINATED CPL 0,5 mm*											
LAMINATED CPL 0,7 mm*											
LAMINATED HPL*					*available upon consultation with the sales department For door leaves with structure laminate, frame surface with plain laminate.						

DOOR FRAMES

REVES SYSTEM	rebated SYSTEM							
	non-rebated SYSTEM							

EQUIPMENT

STANDARD	
white matt or transparent 4 mm thick glass	third hinge in the door leaf (slab) or adjustable pivot hinge: type K, type C, type M for a width of "60"- "80"
white matt tempered glass plate (version 03SD, leaves - mechanical class III)	type T
single-point mortise lock, spacing: 72 mm (rebated system) or magnetic mortise lock (non-rebated system), key-operated (spacing: 90 mm), for a cylinder (spacing: 85 mm) or a bathroom lock (spacing: 90 mm)	concealed DUO type for a width of "60"- "70"
lock with stainless steel face plate (leaves - mechanical class III)	rail and stile set (allowing the user to shorten the door leaf (slab) by max. 50 mm on a do-it-yourself basis)
hinges: type K - for the DIN system door frame, type C - for the wooden door frame, type M - for the metal door frame or the concealed DUO satin nickel ("60"- "80" - 2 pcs, "90" - 3 pcs)	rail and stile set (allowing the user to shorten the door leaf (slab) by max. 90 mm on a do-it-yourself basis)
hinges: type K (leaves - mechanical class III) - 3 pcs	reinforcement for door closer
in case of door leaf (slab) with door closer and DIN system or metal frame to be used T type hinges ("60"- "80" - 3 pcs, "90"- "110" - 4 pcs) - replacement of standard hinges with hinge type T for an extra charge	bottom rail and stile set protection against excessive moisture impact (not applicable to leaves with ventilation trim)
ADDITIONAL (available at an extra charge)	door lower by 50 mm or 100 mm (rebated system)
size "100" (glazing decoration as in "90")	door lower by 55 mm or 100 mm (non-rebated system)
size "110" (glazing decoration as in "90")	non-standard height
REVES system (version 00)	door higher by 50 mm or 100 mm (third hinge in the door leaf (slab) is required)
recuperation trim	door higher by 150 mm or 200 mm (third hinge in the door leaf (slab) is required)
CPL laminate available at an extra charge 0.5 mm, 0.7 mm ("60" - "90")*	ventilation trim (p. 159)
CPL laminate available at an extra charge 0.5 mm, 0.7 mm ("90" - "110")*	tempered glass (version 02, 04, 05)
extra charge for SILKSTONE CPL colours	tempered transparent 4 mm thick glass
perforated chipboard in-fill	edges in other colours - black, grey, graphite - are available
solid chipboard in-fill (third hinge recommended)	ABS edging in black, white, titano, polish oak or anthracite (not applicable to REVES system)

*an extra charge to the standard height

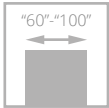

for door leaves with ventilation option



SEMPRE LUX

NEW COLOUR



- **solid construction – wooden rail and stile set**
- **natural veneers** surface finish
- **ecological UV varnish** ensures incredible permanence of colour and scratch resistance
- leaves available with a **one-sided magnetic board (Z/AZ)** and a **one-sided mirror (WL Z, WL A/Z)**
- K and C type adjustable and DUO type concealed hinges



rail and stile set wood grain



wood grain of panels - horizontal

SEMPRE LUX door, W04 version, SYSTEM DIN adjustable door frame



SEMPRE LUX door, W03S4 version, POL-SKONE SYSTEM adjustable door frame



VERSION W00 / V01 W01 / V1SD W04 / V4SM W05 / V4SD board* mirror* Z A/Z WLZ WLA/Z W02P / V02 W02 / V2S5 W02S1 / V2S1 W02S2 / V2S2



VERSION W02S3 / V2S3 W02S4 / V2S4 W02A / V2SA W03P / V03 W03 / V3S5 W03S1 / V3S1 W03S2 / V3S2 W03S3 / V3S3 W03S4 / V3S4 W03A / V3SA

* Z, WLZ - board/mirror on the hinge side, A/Z, WLA/Z - board/mirror on the side opposite to the hinge side



VERSION W06 / V05 W07 / V06 W05 VERSE / V6SD

COLOURS

VENEERED GROUP A	311	312	334		
	bright oak*	swiss pine*	European oak		
	323	340	351	376	
VENEERED GROUP B	rustic oak	ebony	marrone	steel oak	
	404	405	421	422	424
	dark walnut	bright walnut	cappuccino	mocca	teak
VENEERED GROUP C	370	NEW 452			
	white-stained oak	grey mat**			

* available upon consultation with the Sales Department

** applicable to W00 version

DOOR FRAMES

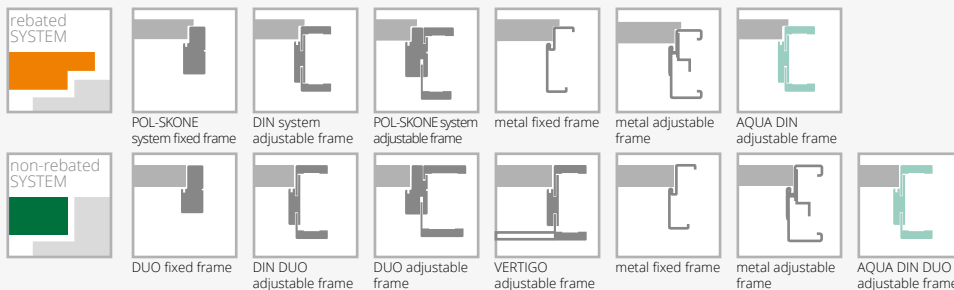

EQUIPMENT

STANDARD

white/brown/graphite or transparent 4 mm glass
version W01, W05 - tempered glass pane 4 mm

version W00, panel thickness: 12 mm

single-point mortise lock, spacing: 72 mm (rebated system) or magnetic mortise lock (non-rebated system), key-operated (spacing: 90 mm), for a cylinder (spacing: 85 mm) or a bathroom lock (spacing: 90 mm)

hinges: type K satin nickel - for the DIN system door frame, type C satin nickel - for the wooden door frame, type M - for the metal door frame or the concealed DUO satin nickel ("60"- "80" - 2 pcs, "90" - 3 pcs)

door closer is not available

drop seal is not available

version W05 VERSE - applicable to "70" - "100" width

ADDITIONAL (available at an extra charge)

size "100"

recuperation trim (only standard height)

third hinge in the door leaf (slab):

type K, type C, type M for a width of "60"- "80"

concealed DUO type for a width of "60"- "80"

door lower by 50 mm (rebated system) (not applicable to WLZ, WLA/Z)

door lower by 55 mm (non-rebated system) (not applicable to WLZ, WLA/Z)

door higher by 50 mm or 100 mm (not applicable to WLZ, WLA/Z) (third hinge in the door leaf (slab) is required)

ventilation trim (p. 159)

VSG 22.1 laminated black glass:

version W02, W03

tempered transparent 4 mm thick glass

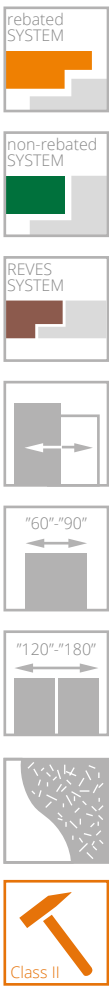

TEO

NEW



- door covered with **natural veneer**
- ecological **UV varnish** ensures incredible **permanence of colour** and **scratch resistance**
- an unique **decorative milling** in the colour of **black, protected with varnish**

TEO door, VF1 version, SYSTEM DIN adjustable door frame

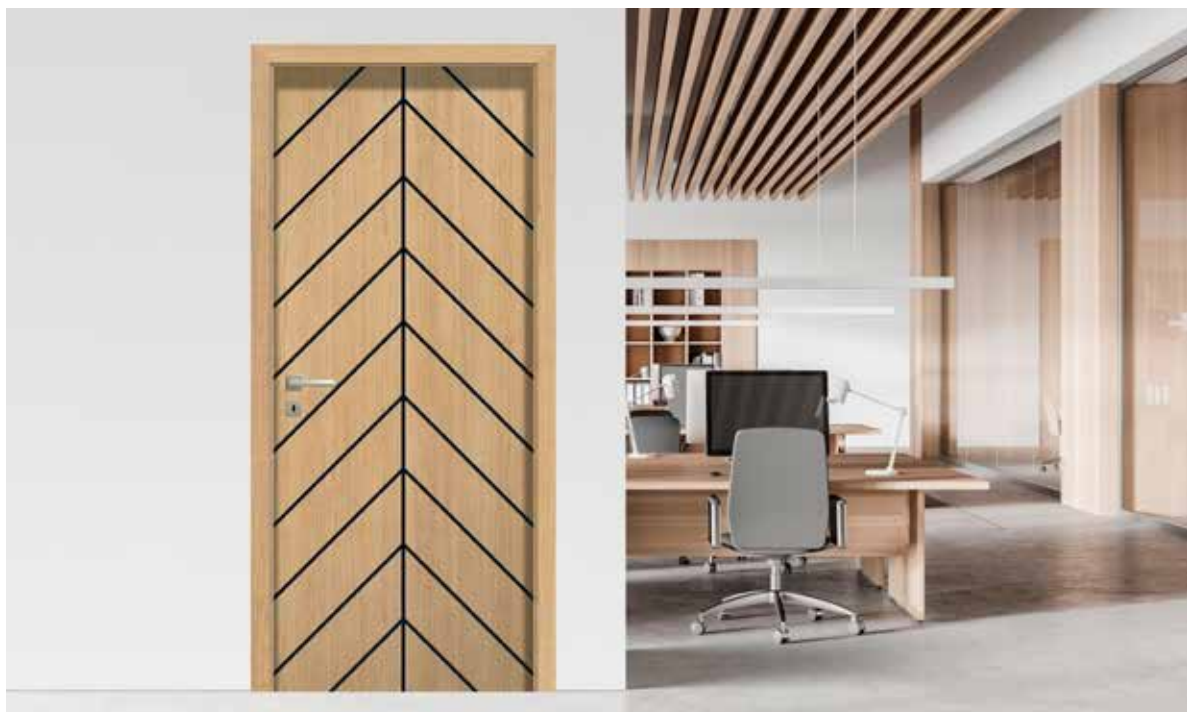

TEO door, VF6 version, SYSTEM DIN adjustable door frame



VERSION VF1 VF2 VF3 VF4



VERSION VF5 VF6 VF7

COLOURS

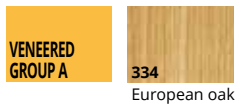

DOOR FRAMES

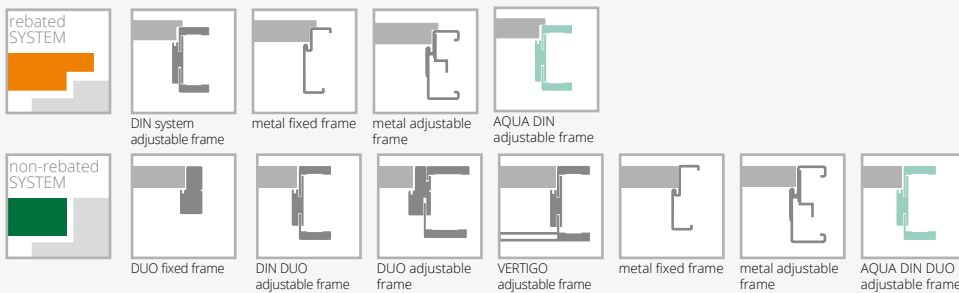

EQUIPMENT

STANDARD
 wooden rail and stile set topped with two HDF boards with the veneered surface with decorative milled in the colour of black
 single-point mortise lock, spacing: 72 mm (rebated system) or magnetic mortise lock (non-rebated system), key-operated (spacing: 90 mm), for a cylinder (spacing: 85 mm) or a bathroom lock (spacing: 90 mm) in the colour of black
 black hinges: type T – for the DIN system door frame and the metal door frame, ("60"- "80" – 2 pcs, "90" – 3 pcs) or the concealed DUO ("60"- "70" – 2 pcs, "80"- "90" – 3 pcs)

ADDITIONAL (available at an extra charge)
 size "100"
 third hinge in the door leaf (slab):
 type T for a width of "60"- "80"
 concealed DUO type for a width of "60"- "70"
 the lock colour replaced with silver colour
 rail and stile set (allowing the user to shorten the door leaf (slab) by max. 50 mm on a do-it-yourself basis)
 rail and stile set (allowing the user to shorten the door leaf (slab) by max. 90 mm on a do-it-yourself basis)
 reinforcement for door closer
 bottom rail and stile set protection against excessive moisture impact (not applicable to leaves with ventilation trim)
 ventilation trim

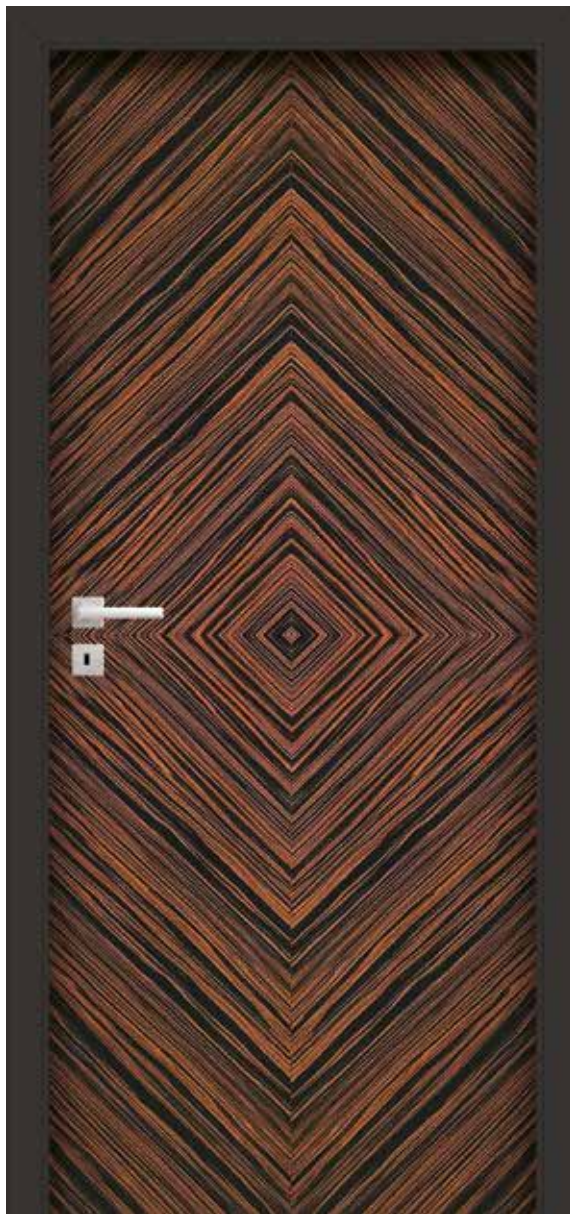
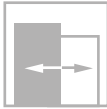
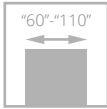

ESPINA

NEW
VERSION



- **solid construction – wooden rail and stile set**
- stable perforated **chipboard in-fill**
- **perfect combination** of black and natural veneer
- ecological UV varnish ensures incredible **permanence of colour and scratch resistance**
- white matt **tempered glass**, thickness: 6 mm or laminated glass VSG 44.2 in the colour of black, 8.5 mm thick
- K and C type adjustable and DUO type concealed hinges



ESPINA door, W03 version, SYSTEM DIN adjustable door frame

wood grain



ESPINA door, W03 version, SYSTEM DIN door frame



VERSION W00 / V00 W01 / V1S W01 / V1S W02 / V01 W03 / V03

COLOURS

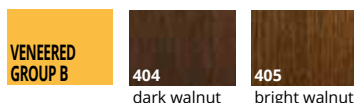

DOOR FRAMES

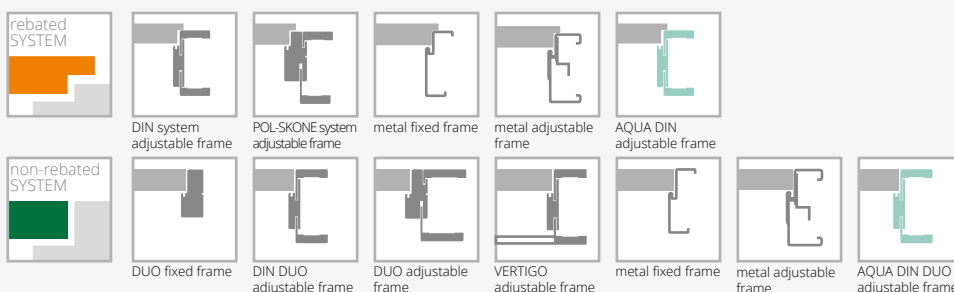

EQUIPMENT

STANDARD

white matt tempered glass, thickness: 6 mm
laminated glass 44.2 in the colour of black, 8.5 mm thick
single-point mortise lock, spacing: 72 mm (rebated system) or magnetic mortise lock (non-rebated system), key-operated (spacing: 90 mm), for a cylinder (spacing: 85 mm) or a bathroom lock (spacing: 90 mm)
hinges: type K – for the DIN system door frame, type C – for the wooden door frame, type M – for the metal door frame ("60"- "80" – 2 pcs, "90" – 3 pcs) or the concealed DUO satin nickel ("60"- "70" – 2 pcs, "80"- "90" – 3 pcs)
in case of door leaf (slab) with door closer and DIN system or metal frame to be used T type hinges ("60"- "80" – 3 pcs, "90"- "110" – 4 pcs) - replacement of standard hinges with hinge type T for an extra charge

ADDITIONAL (available at an extra charge)

size "100"
size "110" (applicable to version W00, W02, W03)
REVES system (version W00, W01, W02, W03)
recuperation trim

perforated chipboard in-fill (third hinge in the door leaf (slab) is required)

third hinge in the door leaf (slab):

type T, type K, type C, type M for a width of "60"- "80" concealed DUO type for a width of "60"- "70"

rail and stile set (allowing the user to shorten the door leaf (slab) by max. 50 mm on a do-it-yourself basis) not applicable to W01

rail and stile set (allowing the user to shorten the door leaf (slab) by max. 90 mm on a do-it-yourself basis) not applicable to W01

reinforcement for door closer (not applicable to W01 version)

bottom rail and stile set protection against excessive moisture impact (not applicable to leaves with ventilation trim)

door lower by 50 mm or 100 mm (rebated system)

door lower by 55 mm or 100 mm (non-rebated system)

door higher by 50 mm or 100 mm (third hinge in the door leaf (slab) is required)

door higher by 150 mm or 200 mm (third hinge in the door leaf (slab) is required)

ventilation trim (version W00, W01, W02, W03) (p. 159)

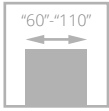

DECO LUX

with the Soft frame



- **solid construction – wooden rail and stile set**
- door covered with **natural veneers**
- **ecological UV varnish** ensures incredible permanence of colour and scratch resistance
- K and C type adjustable and DUO type concealed hinges

DECO LUX door, 00 version, SYSTEM DIN adjustable door frame



DECO LUX door, 00 version, SYSTEM DIN door frame



VERSION **00 / V00** **02 / V2S** **03SD / V3SD** **04 / V4SD** **05 / V5SD**

COLOURS

VENEERED GROUP A	311 bright oak*	312 swiss pine*	334 European oak			
	VENEERED GROUP B	323 rustic oak	340 ebony	376 steel oak	390 natural walnut	
		404 dark walnut	405 bright walnut	421 cappuccino	422 mocca	424 teak
		370 white-stained oak	450 white matt	451 black matt		
VENEERED GROUP C			VENEERED GROUP D	makassar		

* available upon consultation with the Sales Department

DOOR FRAMES

EQUIPMENT

STANDARD	<p>white matt or transparent 4 mm thick glass</p> <p>version 03SD: white matt tempered glass</p> <p>single-point mortise lock, spacing: 72 mm (rebated system) or magnetic mortise lock (non-rebated system), key-operated (spacing: 90 mm), for a cylinder (spacing: 85 mm) or a bathroom lock (spacing: 90 mm)</p> <p>hinges: type K – for the DIN system door frame, type C – for the wooden door frame, type M – for the metal door frame or the concealed DUO satin nickel ("60"-80" – 2 pcs, "90" – 3 pcs)</p> <p>in case of door leaf (slab) with door closer and DIN system or metal frame to be used T type hinges ("60"-80" – 3 pcs, "90"-110" – 4 pcs) - replacement of standard hinges with hinge type T for an extra charge</p> <p>ADDITIONAL (available at an extra charge)</p> <p>size "100" (glazing decoration as in "90")</p> <p>size "110" (glazing decoration as in "90")</p> <p>REVES system (version 00)</p> <p>recuperation trim</p> <p>perforated chipboard in-fill</p> <p>solid chipboard in-fill (third hinge recommended)</p> <p>third hinge in the door leaf (slab): type K, type C, type M for a width of "60"-80" concealed DUO type for a width of "60"-80"</p>	<p>rail and stile set (allowing the user to shorten the door leaf (slab) by max. 50 mm on a do-it-yourself basis)</p> <p>rail and stile set (allowing the user to shorten the door leaf (slab) by max. 90 mm on a do-it-yourself basis)</p> <p>reinforcement for door closer</p> <p>bottom rail and stile set protection against excessive moisture impact (not applicable to leaves with ventilation trim)</p> <p>door lower by 50 mm or 100 mm (rebated system)</p> <p>door lower by 55 mm or 100 mm (non-rebated system)</p> <p>door higher by 50 mm or 100 mm (third hinge in the door leaf (slab) is required)</p> <p>door higher by 150 mm or 200 mm (third hinge in the door leaf (slab) is required)</p> <p>ventilation trim (p. 159)</p> <p>tempered glass (version 02, 04, 05)</p> <p>tempered transparent 4 mm thick glass</p> <p>DECO LUX door in mechanical class III available on request</p>	<p>technical door catalogue</p>
-----------------	---	---	---------------------------------



ETIUDA LUX door, A01 version, SYSTEM DIN adjustable door frame

ETIUDA LUX

- **solid construction – wooden rail and stile set**
- door covered with **natural veneers**
- **ecological UV varnish** ensures incredible permanence of colour and scratch resistance
- white matt or graphite **tempered glass**, thickness: 6 mm
- aluminium decorative strips in the colour of silver or black
- K and C type adjustable and DUO type concealed hinges



aluminium decorative strips in the colour of silver or black

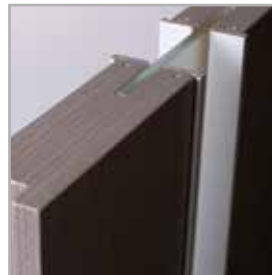

top door leaf (slab) edge without a rebate



option: aluminium decorative strips in the colour of black



ETIUDA LUX door, A02 version, SYSTEM DIN adjustable door frame



VERSION **B0 / V00** **B1 / VD11** **A01 / V1SA** **A02 / V2SA** **A03 / V3SA**

COLOURS



* available upon consultation with the Sales Department

DOOR FRAMES

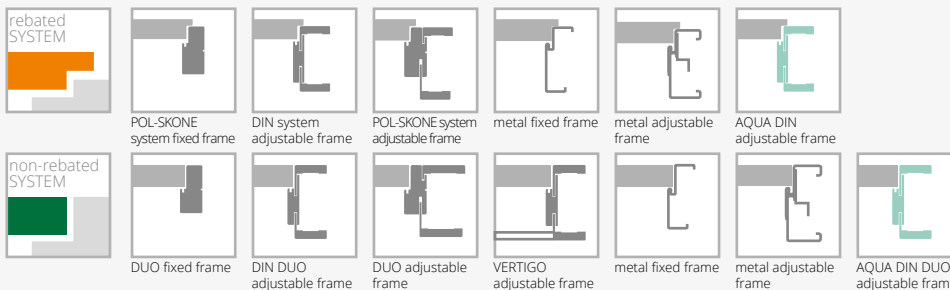

EQUIPMENT

STANDARD
 white/brown matt tempered glass, thickness: 6 mm
 black-coloured glass pane is not available
 glazing width in the A01 version – 54 mm; A02 – 205 mm, A03 – 276 mm*
 single-point mortise lock, spacing: 72 mm (rebated system) or magnetic mortise lock (non-rebated system), key-operated (spacing: 90 mm), for a cylinder (spacing: 85 mm) or a bathroom lock (spacing: 90 mm)
 hinges: type K – for the DIN system door frame, type C – for the wooden door frame, type M – for the metal door frame or the concealed DUO satin nickel ("60"- "80" – 2 pcs, "90" – 3 pcs)
ADDITIONAL (available at an extra charge)
 size "100"
 size "110" (applicable to version B0, B1)
 solid chipboard in-fill (version B0, A01, A02, A03) (third hinge recommended)
 third hinge in the door leaf (slab):
 type K, type C, type M for a width of "60"- "80"
 concealed DUO type for a width of "60"- "80"
 rail and stile set (allowing the user to shorten the door leaf (slab) by max. 50 mm on a do-it-yourself basis) (applicable to version B0)
 rail and stile set (allowing the user to shorten the door leaf (slab) by max. 90 mm on a do-it-yourself basis) (applicable to version B0)
 change of colour of decorative strips to black:
 version B1
 version A01-A03
 +/- 2 mm tolerance

reinforcement for door closer (not applicable to version A01, A02, A03)
 bottom rail and stile set protection against excessive moisture impact (not applicable to leaves with ventilation trim) (not applicable to version A01, A02, A03)
 door lower by 50 mm or 100 mm (rebated system) (not applicable to version A01, A02, A03)
 door lower by 55 mm or 100 mm (non-rebated system) (not applicable to version A01, A02, A03)
 door higher by 50 mm or 100 mm (not applicable to version A01, A02, A03) (third hinge in the door leaf (slab) is required)
 door higher by 150 mm or 200 mm (not applicable to version A01, A02, A03) (third hinge in the door leaf (slab) is required)
 version A01, A02, A03 door lower by 50 mm (rebated system)
 version A01, A02, A03 door lower by 55 mm (non-rebated system)
 version A01, A02, A03 door higher by 100 mm (third hinge in the door leaf (slab) is required)
 version A01, A02, A03 door higher by 200 mm (third hinge in the door leaf (slab) is required)
 ventilation trim (applicable to versions B0) (p. 159)
 ventilation trim A01 with the "60" - "100" widths (p. 159)
 ventilation trim A02, A03 with the "70" - "100" widths (p. 159)
 tempered 6 mm glass in the colour of graphite or transparent
 sliding system (not applicable to version A01)

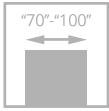

for door leaves with ventilation option



FORTIMO LUX

- **solid construction – wooden rail and stile set**
- door covered with **natural veneers**
- **ecological UV varnish** ensures incredible permanence of colour and scratch resistance
- cross rails come with a **vertical wood grain**
- white and brown matt, graphite or transparent **tempered glass**, thickness: 4 mm
- K and C type adjustable and DUO type concealed hinges



glazing, panel



interconnection of architraves at the 45° angle

FORTIMO LUX door, W03 version, SYSTEM DIN adjustable door frame



FORTIMO LUX door, W03S1 version, SYSTEM VERTIGO adjustable door frame



VERSION **W01 / V01** **W01S1 / V1S** **W03 / V02** **W03S1 / V2S**

COLOURS

VENEERED GROUP A	311 bright oak*	312 swiss pine*	334 European oak		
	323 rustic oak	340 ebony	351 marrone	376 steel oak	
	390 natural walnut	404 dark walnut	405 bright walnut	421 cappuccino	422 mocca
VENEERED GROUP C	370 white-stained oak				

* available upon consultation with the Sales Department

DOOR FRAMES

rebated SYSTEM							
	non-rebated SYSTEM						

EQUIPMENT

STANDARD	ADDITIONAL (available at an extra charge)
white matt tempered glass, thickness: 4 mm	size "100"
single-point mortise lock, spacing: 72 mm (rebated system) or magnetic mortise lock (non-rebated system), key-operated (spacing: 90 mm), for a cylinder (spacing: 85 mm) or a bathroom lock (spacing: 90 mm)	recuperation trim (only standard height)
hinges: type K – for the DIN system door frame, type C – for the wooden door frame, type M – for the metal door frame or the concealed DUO satin nickel ("70"- "80" – 2 pcs, "90" – 3 pcs)	size "60" (applicable to W01, W01S1)
	third hinge in the door leaf (slab): type K, type C, type M for a width of "60"- "80" concealed DUO type for a width of "60"- "80"
	door lower by 50 mm (rebated system)
	door lower by 55 mm (non-rebated system)
	laminated glass VSG 22.1 matt, transparent or black
	ventilation trim (p. 159)
	brown/graphite or transparent tempered 4 mm thick glass

SONATA LUX

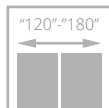
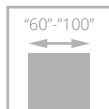

- **solid construction - wooden rail and stile set**
- **stable perforated chipboard** in-fill
- door covered with **natural veneers**
- **ecological UV varnish** ensures incredible permanence of colour and scratch resistance
- **aluminium decors** on the leaf (slab) surface in the colour of black, golden gloss, chrome gloss
- K and C type adjustable and DUO type concealed hinges

SONATA LUX door, W5 version, SYSTEM DIN adjustable door frame



SONATA LUX door, W2 version, DIN adjustable door frame

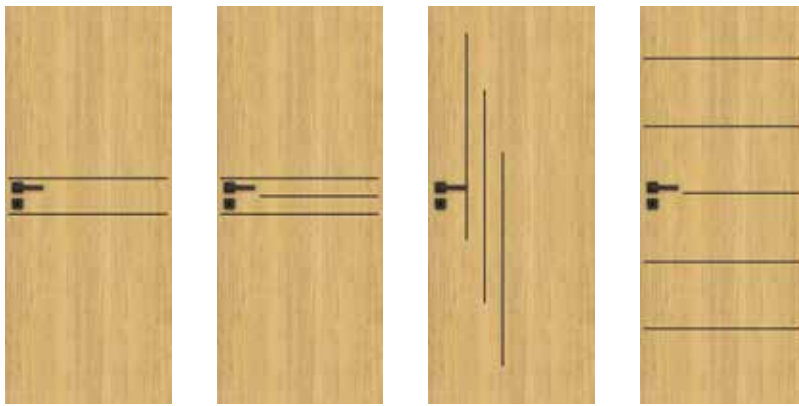

VERSION **W1 / VD1** **W2 / VD2** **W4 / VD4** **W5 / VD5**

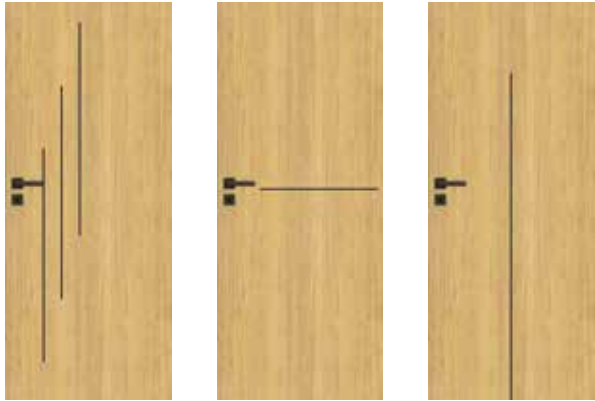

VERSION **W6 / VD6** **W7 / VD7** **W8 / VD8**

COLOURS

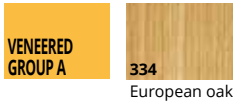

DOOR FRAMES

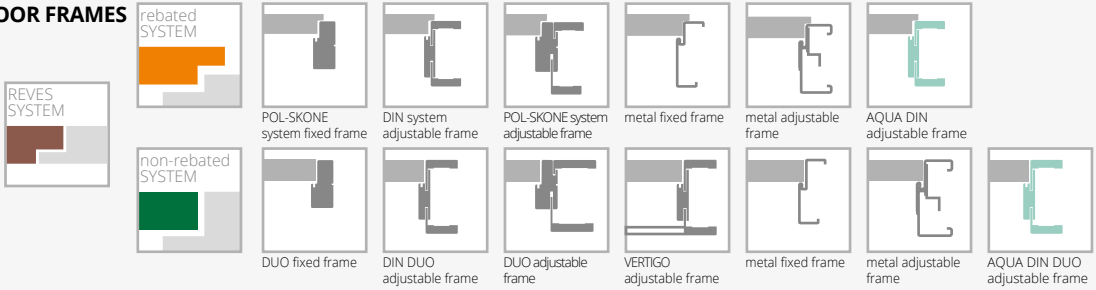

EQUIPMENT

STANDARD
 single-point mortise lock, spacing: 72 mm (rebated system) or magnetic mortise lock (non-rebated system), key-operated (spacing: 90 mm), for a cylinder (spacing: 85 mm) or a bathroom lock (spacing: 90 mm)
 hinges: type K – for the DIN system door frame, type C – for the wooden door frame, type M – for the metal door frame or the concealed DUO satin nickel ("60"- "70" – 2 pcs, "80"- "90" – 3 pcs) in case of door leaf (slab) with door closer and DIN system or metal frame to be used T type hinges ("60"- "80" – 3 pcs, "90"- "100" – 4 pcs) - replacement of standard hinges with hinge type T for an extra charge
ADDITIONAL (available at an extra charge)
 size "100"
 REVES system
 recuperation trim
 solid chipboard in-fill (third hinge recommended)
 third hinge in the door leaf (slab):
 type K, type C, type M for a width of "60"- "80"
 concealed DUO type for a width of "60"- "70"
 the type T hinge in colour of black (rebated system)
 the DUO hinge colour replaced with black colour (non-rebated system)

the DUO lock colour replaced with black colour (non-rebated system)
 rail and stile set (allowing the user to shorten the door leaf (slab) by max. 50 mm on a do-it-yourself basis) (not applicable to version W8)
 rail and stile set (allowing the user to shorten the door leaf (slab) by max. 90 mm on a do-it-yourself basis) (not applicable to version W8)
 reinforcement for door closer
 bottom rail and stile set protection against excessive moisture impact (not applicable to leaves with ventilation trim)
 door lower by 50 mm (rebated system)
 door lower by 55 mm (non-rebated system)
 door higher by 50 mm or 100 mm (third hinge in the door leaf (slab) is required)
 door higher by 150 mm or 200 mm (third hinge in the door leaf (slab) is required)
 ventilation trim (p. 159)
 aluminium decors in black, chrome gloss, golden gloss
 leaf (slab) edge in the colour of black

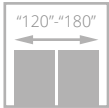
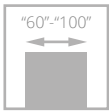

for door leaves with ventilation option



INTERSOLID door, 02 version, SYSTEM DIN adjustable door frame

INTERSOLID

NEW COLOUR



- **solid construction – wooden rail and stile set**
- door covered with **natural veneers**
- **ecological UV varnish** ensures incredible permanence of colour and scratch resistance
- K and C type adjustable hinges



INTERSOLID frame



INTERSOLID door, 05 version (door on the left side), 05 S8 version (door on the right side), SYSTEM DIN adjustable door frame



VERSION **02 / V02** **02S6 / V2S6** **05 / V05** **05S8 / V5S8** **08 / V08** **08S10 / V8S10**

COLOURS

VENEERED GROUP A		311 bright oak*		312 swiss pine*		334 European oak
		323 rustic oak		340 ebony		404 dark walnut
		405 bright walnut		421 cappuccino		422 mocca
		424 teak				
VENEERED GROUP B		370 white-stained oak		NEW 452 grey mat**		
	* available upon consultation with the Sales Department ** applicable to 08 version					

DOOR FRAMES

	POL-SKONE system fixed frame	DIN system adjustable frame	POL-SKONE system adjustable frame	metal fixed frame	metal adjustable frame	AQUA DIN adjustable frame

EQUIPMENT

STANDARD	ADDITIONAL (available at an extra charge)
white matt or transparent 4 mm thick glass	size "100"
single-point mortise lock, spacing: 72 mm key-operated or cylinder type, for a cylinder or a bathroom lock	third hinge in the door leaf (slab): type K, type C, type M for a width of "60"- "80"
hinges: type K - for the DIN system door frame, type C - for the wooden door frame, type M - door leaf (slab) for the metal door frame ("60"- "80" - 2 pcs, "90" - 3 pcs)	bottom rail and stile set protection against excessive moisture impact (not applicable to leaves with ventilation trim)
	door lower by 50 mm
	door higher by 50 mm or 100 mm (third hinge in the door leaf (slab) is required)
	ventilation trim (p. 159)
	white matt or transparent tempered 4 mm thick glass

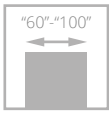

for door leaves with ventilation option



INTERSOLID II door, 02 S6 version, SYSTEM DIN adjustable door frame

INTERSOLID II



- **solid construction – wooden rail and stile set**
- door covered with **natural veneers**
- **ecological UV varnish** ensures incredible permanence of colour and scratch resistance
- **milled panel**
- K and C type adjustable hinges



wooden muntin



door leaf (slab) profile



INTERSOLID II door, 02 version, adjustable door frame



VERSION **01 / V01** **01S6 / V1S6** **02 / V02** **02S6 / V2S6** **03 / V03** **03S6 / V3S6** **04 / V04** **04S8 / V4S8** **05 / V05**



VERSION **05S8 / V5S8** **06 / V06** **06S8 / V6S8** **07 / V07** **07S10 / V7S10** **08 / V08** **08S10 / V8S10** **09 / V09** **09S10 / V9S10**

COLOURS

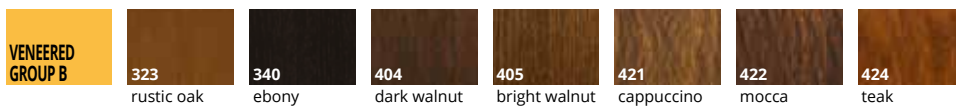

* available upon consultation with the Sales Department

DOOR FRAMES

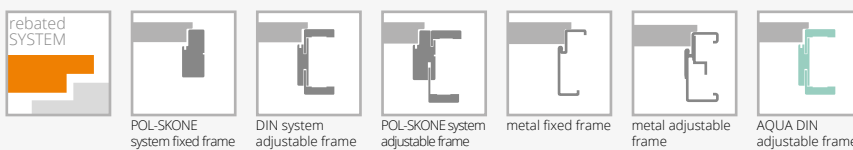

EQUIPMENT

STANDARD	ADDITIONAL (available at an extra charge)
white matt or transparent 4 mm thick glass	size "100"
single-point mortise lock, spacing: 72 mm key-operated or cylinder type, for a cylinder or a bathroom lock	third hinge in the door leaf (slab): type K, type C, type M for a width of "60"- "80"
hinges: type K - for the DIN system door frame, type C - for the wooden door frame, type M - door leaf (slab) for the metal door frame ("60"- "80" - 2 pcs, "90" - 3 pcs)	bottom rail and stile set protection against excessive moisture impact (not applicable to leaves with ventilation trim)
	door lower by 50 mm
	door higher by 50 mm or 100 mm (third hinge in the door leaf (slab) is required)
	ventilation trim (p. 159)
	white matt or transparent tempered 4 mm thick glass

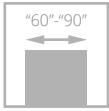

for door leaves with ventilation option



PASSO

- **solid construction – wooden rail and stile set**
- large LAMISTONE CPL, SILKSTONE and **natural veneers surface finish**
- stile - vertical or horizontal wood grain (version H), horizontal cross rails
- 24 mm thick panels
- K and C type adjustable and DUO type concealed hinges

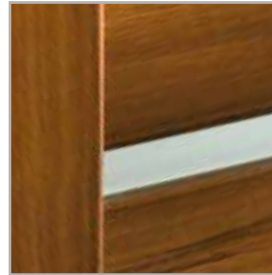

rail and stile set, cross rails and glass pane connection



top door leaf (slab) edge without a rebate

PASSO door, W05 version, SYSTEM DIN DUO adjustable door frame











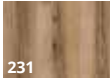
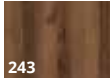

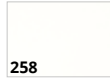
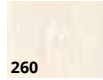

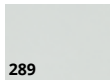
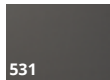

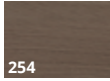

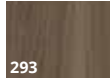

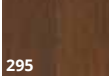
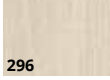
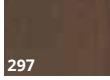
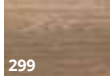
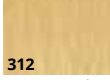
PASSO door, W03 version (door on the left side), W02 (door on the right side), DUO adjustable door frame



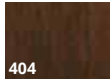

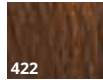







VERSION **W01 / V01** **W02 / V1S1** **W03 / V1S2** **W04 / V1S3** **W05 / V1S4** **W06 / V2SD** **W07 / V3SD**

COLOURS

LAMISTONE CPL	 231 halif oak	 243 delano oak	 244 black	 250 terra oak	 258 white	 260 white oak
	 263 premium walnut	 265 wenge	 289 grey	 531 anthracite	 232 segato walnut	
SILKSTONE	 230 gran oak	 254 Royal anthracite H	 255 Polish ash H	 276 Polish oak	 293 Royal anthracite	 294 Royal ash
	 295 Royal merbau	 296 Polish ash	 297 Royal nougat	 299 Royal ash H		
VENEERED GROUP A	 312 swiss pine*	 334 European oak				
VENEERED GROUP B	 340 ebony	 376 steel oak	 404 dark walnut	 405 bright walnut	 421 cappuccino	 422 mocca
	 424 teak					

* available upon consultation with the Sales Department

DOOR FRAMES

					
	POL-SKONE system fixed frame	DIN system adjustable frame	POL-SKONE system adjustable frame	AQUA DIN adjustable frame	
					
	DUO fixed frame	DIN DUO adjustable frame	DUO adjustable frame	VERTIGO adjustable frame	AQUA DIN DUO adjustable frame

EQUIPMENT

STANDARD	ADDITIONAL (available at an extra charge)
<p>painting white/brown matt or transparent 4 mm glass</p> <p>single-point mortise lock, spacing: 72 mm (rebated system) or magnetic mortise lock (non-rebated system), key-operated (spacing: 90 mm), for a cylinder (spacing: 85 mm) or a bathroom lock (spacing: 90 mm)</p> <p>hinges: type K – for the DIN system door frame, type C – for the wooden door frame or the concealed DUO satin nickel ("60"- "80" – 2 pcs, "90" – 3 pcs)</p> <p>door closer is not available</p> <p>drop seal is not available</p>	<p>third hinge in the door leaf (slab):</p> <p>type K, type C for a width of "60"- "80"</p> <p>concealed DUO type for a width of "60"- "80"</p> <p>door lower by 55 mm (non-rebated system)</p> <p>door lower by 50 mm (rebated system)</p> <p>ventilation trim (p. 159)</p> <p>tempered transparent 4 mm thick glass</p>

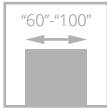

ESTATO LUX



- **solid construction – wooden rail and stile set**
- **stable perforated chipboard** in-fill
- door covered with **natural veneers**
- **ecological UV varnish** ensures incredible permanence of colour and scratch resistance
- **vertical wood grain**
- **security, tempered** glass pane, white/brown matt, thickness: 6 mm or **VSG 44.2 laminated glass** in the colour of black, thickness: 8,5 mm



ESTATO LUX door, A01 version, SYSTEM DIN adjustable door frame

black pane



ESTATO LUX door, A01 version, SYSTEM DIN DUO adjustable door frame



WHITE/BROWN MAT TEMPERED GLASS

BLACK LAMINATED GLASS

VERSION **A01 / V1SA** **A02 / V2SA** **A03 / V3SA** **A01 / V1SA black glass** **A02 / V2SA black glass** **A03 / V3SA black glass**



WHITE MATT LAMINATED GLASS

VERSION **A01 / V1SA** **A02 / V2SA** **A03 / V3SA**

COLOURS



* available upon consultation with the Sales Department

DOOR FRAMES

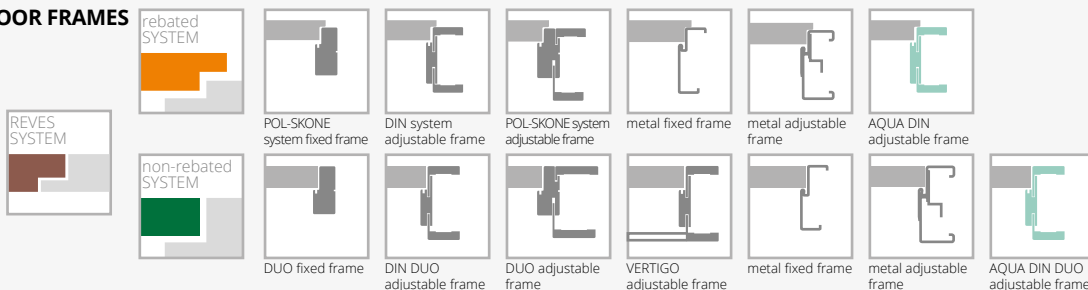

EQUIPMENT

STANDARD
 white/brown matt tempered glass, thickness: 6 mm (versions A01-58 mm, A02-208 mm, A03-280 mm)*
 laminated glass 44.2 in the colour of black or white matt, 8.5 mm thick
 single-point mortise lock, spacing: 72 mm (rebated system) or magnetic mortise lock (non-rebated system), key-operated (spacing: 90 mm), for a cylinder (spacing: 85 mm) or a bathroom lock (spacing: 90 mm)
 hinges: type T – for the DIN system door frame or for the metal door frame, type C – for the wooden door frame ("60"- "80" – 2 pcs, "90" – 3 pcs) or the concealed DUO satin nickel for non-rebated system ("60"- "70" – 2 pcs, "80"- "90" – 3 pcs)
 door closer is not available

ADDITIONAL (available at an extra charge)
 size "100"
 REVES system
 solid chipboard in-fill (third hinge recommended)
 +/- 1-2 mm tolerance

third hinge in the door leaf (slab):
 type C for a width of "60"- "80"
 type T for a width of "60"- "80"
 concealed DUO type for a width of "60"- "70"
 version A01, A02, A03 door lower by 50 mm (rebated system)
 version A01, A02, A03 door lower by 55 mm (non-rebated system)
 version A01, A02, A03 door higher by 100 mm (third hinge in the door leaf (slab) is required)
 version A01, A02, A03 door higher by 200 mm (third hinge in the door leaf (slab) is required)
 ventilation trim (not applicable to versions A02, A03) (p. 159)
 ventilation trim A01 with the "60" - "100" widths (p. 159)
 ventilation trim A02, A03 with the "70" - "100" widths (p. 159)
 tempered 6 mm glass in the colour of graphite or transparent
 sliding system (not applicable to the version A01)

SLIDING SYSTEM FOR IN-WALL INSTALLATION

EQUIPMENT

hook lock (chrome) for the privacy lock	
system brushes	
door leaf (slab) alone for the sliding system	
replacement of the regular lock with a key-operated bathroom lock (WC)	
cassettes for the in-wall sliding door system*	
pull handles for sliding doors for the in-wall installation	p. 163
SP60 closer** for the single leaf (slab) door	
SP60 closer** for the double leaf (slab) door	

An encasement and cassette higher by 100 mm and 200 mm are available on request.

A non-symmetrical installation is available upon consultations with the POL-SKONE sales department.

BUILT-IN SLIDING DOOR, RIGHT-LEFT SYMMETRICAL

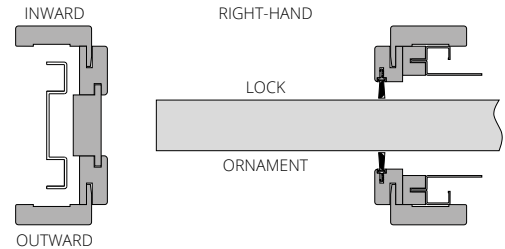

single cassette (100 or 125 mm)
leaf (slab) dimensions
"60" (G/60)
"70" (G/70)
"80" (G/80)
"90" (G/90)
"100" (G/100)
extra charge
cassette higher by 100 mm Ho=2175 mm
cassette higher by 200 mm Ho=2275 mm
for the synchronisation (simultaneous opening) system in double leaf (slab) doors

double cassette (100 or 125 mm)
leaf (slab) dimensions
"60"+"60" (GG/60)
"70"+"70" (GG/70)
"80"+"80" (GG/80)
"90"+"90" (GG/90)
"100"+"100" (GG/100)
auxiliary products
white brush SB 01
black brush SB 03

* Cassettes for the in-wall sliding door system (the minimum thickness of the single or double cassette with the G/K encasement is: 100 mm for flat leaves; 125 mm for leaves with a decor and glazed with frames)

** Equipped with the SP60 closer for the system concealed in the wall:
- single leaf (slab) door width "60" - "100"
- double leaf (slab) door width "60" + "60" - "90" + "90" without the leaf (slab) or double leaf (slab) door closing synchronisation width
"80" + "80" - "90" + "90" with the leaf (slab) closing synchronization.
Due to the specific installation procedure, the SP60 door closer cannot be used in the following door models: ETIUDA/ETIUDA LUX - A02, A03; PASSO, ESTADO/ESTATO LUX - A02, A03.

Symmetry is not possible for doors with a pattern/decors



Sliding system for in-wall installation

IN-WALL ENCASMENT SYSTEM

In-wall system price = selected leaf (slab) price + cassette price + price of the single leaf (slab) door in-wall set acc. to the table below. DUO in-wall system price = DUO price + cassette price + price of the single leaf (slab) door in-wall set acc. to the table below.

Complete single leaf (slab) door in-wall system for the 100 mm cassette I
 For leaves: ARCO, ETIUDA, ETIUDA LUX, MODERN, INTERSOLID II, SEMPRE, SEMPRE LUX, FORTIMO, FORTIMO LUX, SONATA, ESTADO, FIORI, SEDO, EGRO, VERI, MODO, SUBITO.
 For flush leaves: INTER-AMBER, IMPULS, SIMPLE, FIORD, DECO LUX, SUBLIME, HAPTIC, ESTADO LUX, TIARA, CAMBIO, DECO, ESPINA, MONA, PASSO.

single leaf (slab) door	ECO TOP	UNI MAT PLUS	PAINTED* white	for the laminated type	VENEERED		
				HIGH TOP			
				LAMISTONE CPL			
				SILKSTONE	GROUP A	GROUP B	GROUP C, D
range in mm 100-106							

Variant I - Table I

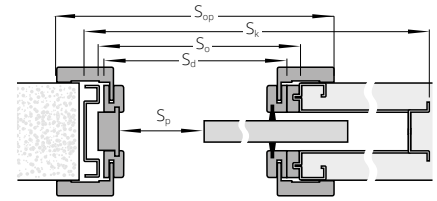

Complete single leaf (slab) door in-wall system for the 125 mm cassette (flush or glazed versions) II
 For leaves: ARCO, INTER-AMBER, IMPULS, ETIUDA, ETIUDA LUX, DECO, SIMPLE, FIORD, CAMBIO, MODERN, SEMPRE, SEMPRE LUX, INTERSOLID II, FORTIMO, FORTIMO LUX, SONATA, SUBLIME, ESTADO, FIORI, ESTADO LUX, VILANO, HAPTIC, TIARA, VERTIGO, DECO LUX, ESPINA, MONA, PASSO, SEDO, CREATO, EGRO, VERI, MODO, SUBITO.

single leaf (slab) door	ECO TOP	UNI MAT PLUS	PAINTED* white	for the laminated type	VENEERED		
				HIGH TOP			
				LAMISTONE CPL			
				SILKSTONE	GROUP A	GROUP B	GROUP C, D
range in mm 125-320							

Variant II - Table II

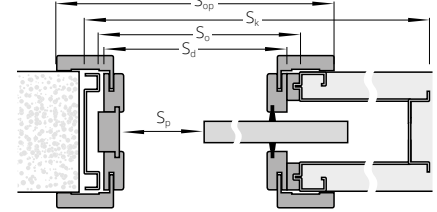

Complete single leaf (slab) door in-wall system for the 125 mm cassette (leaves with decoration) III
 For leaves: NOSTRE, INTERSOLID, INVERNO

single leaf (slab) door	ECO TOP	UNI MAT PLUS	PAINTED* white	for the laminated type	VENEERED		
				HIGH TOP			
				LAMISTONE CPL			
				SILKSTONE	GROUP A	GROUP B	GROUP C, D
range in mm 125-300							

Variant III - Table III

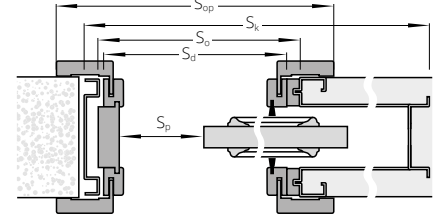

EXTRA CHARGES

for double leaf (slab) doors
width "100"
architraves 80 mm
architraves interconnected at the 90° angle

WIDTH

single leaf (slab) door Dimensions on the external side of: leaves (Ssb, Hsb), door (Sd, Hd)							double leaf (slab) door Dimensions on the external side of: leaves (Ssb, Hsb), door (Sd, Hd)						
TABLE I, II, III													
type	Ssb	Sd	So	Sk	Sp	Sop	type	Ssb	Sd	So	Sk	Sp	Sop
"60"	644	625	650	1307	510	725	"60"+"60"	1288	1216	1250	2520	1030	1316
"70"	744	725	750	1507	610	825	"70"+"70"	1488	1416	1450	2920	1230	1516
"80"	844	825	850	1707	710	925	"80"+"80"	1688	1616	1650	3320	1430	1716
"90"	944	925	950	1907	810	1025	"90"+"90"	1888	1816	1850	3720	1630	1916
"100"	1044	1025	1050	2107	910	1125							

HEIGHT

Hsb	Hd	Ho	Hk	Hp	Hop
2033	2038	2075	2116	2016	2088

Ssb - door leaf (slab) external width
 Sd - door frame external width
 So - door frame installation hole width
 Sk - cassette external width
 Sp - clear opening width
 Sop - architrave external width
 Hsb - door leaf (slab) external height
 Hd - door frame external height
 Ho - door frame installation hole height
 Hk - cassette external height
 Hp - clear opening height
 Hop - architrave external height

*RAL and NCS colours (except the metallic ones)
 - available at an extra charge according to the colour specification table for particular models

SLIDING system ON-WALL

EQUIPMENT ON-WALL SYSTEM

standard:
long brass pull handle chrome satin (U4) p. 163

optional:
pull handles or hook lock p. 163

SP60 closer* for the single leaf (slab) door
SP60 closer* for the double leaf (slab) door
BIAS closer for the single leaf (slab) door
BIAS closer for the double leaf (slab) door

*Equipped with the SP60 closer for the on-wall system:
- single leaf (slab) door width "60 - 100"
- double leaf (slab) door width "60 + 60" - "90 + 90"
Due to the specific installation procedure, the SP60 door closer cannot be used in the following door models: ETIUDA /ETIUDA LUX - A02, A03; PASSO; ESTADO/ESTATO LUX - A02, A03.

In glazed doors – ornament on the outside, in doors with a lock-privacy lock on the inside.
In double leaf (slab) right-hand doors – the lock in the right leaf (slab);
in double leaf (slab) left-hand doors - the lock in the left leaf (slab).

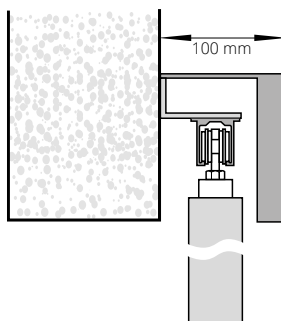

on-wall sliding system
(MDF masking strip made in the colour of the leaf (slab))

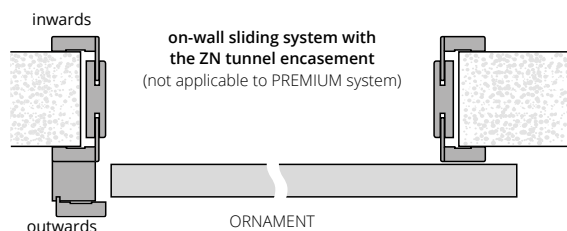

on-wall sliding system with the ZN tunnel encasement
(not applicable to PREMIUM system)

LENGTHS OF MASKING STRIPS FOR THE ON-WALL SYSTEM

"60" - 1795 mm	"60"+"60" - 3448 mm*
"70" - 1795 mm	"70"+"70" - 3448 mm*
"80" - 1795 mm	"80"+"80" - 3448 mm*
"90" - 2045 mm	"90"+"90" - 3948 mm*
"100" - 2295 mm	

* The masking strip is combined of two elements; the masking strip height: 110 mm.



on-wall system guide rail



masking panel and stop post of the on-wall system



door in the SLIDING ON-WALL system

ON-WALL SYSTEM

the price includes: the guide, the masking strip and the stop post*

single leaf (slab) door	PAINTED** white	PAINTED** grey, beige	ECO TOP	UNI MAT PLUS	for the laminated type	VENEERED		
					HIGH TOP	GROUP A	GROUP B	GROUP C, D
					LAMISTONE CPL			
					SILKSTONE			
			wood-like foil		wood-like laminate			
extra charge added to a selected model of interior leaf (slab)								

EXTRA CHARGES

for double leaf (slab) doors
door lower by 50 mm
door higher by 50 mm or 100 mm
door higher by 150 mm or 200 mm
architraves interconnected at the 90° angle (architraves 80 mm width only)
architraves 80 mm width (not applicable to PAINTED)
ventilation options
p. 159

* optionally available: a version with a wall encasement system (a "finishing tunnel") - the price depends on the wall thickness
 ** RAL and NCS colours - available at an extra charge according to the colour specification table.
 The sliding system leaf (slab) is available as a separate item.

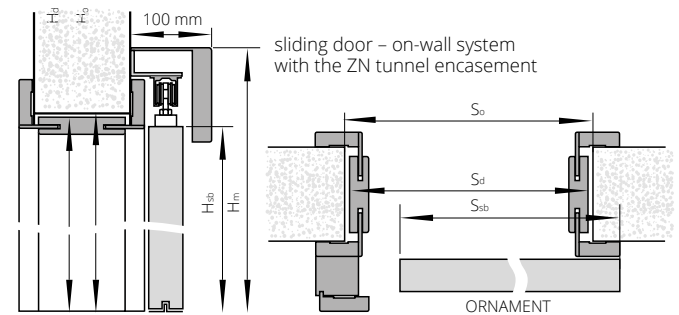
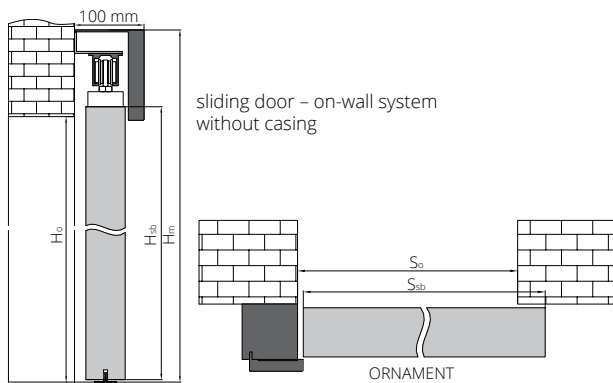

For the on-wall system, we recommend the ZN tunnel encasement (p. 152)

If the tunnel system with 80 mm architraves is used, the lintel architrave must be trimmed during the installation.

WIDTH

single leaf (slab) door dimensions on the external side of leaves (S _{sb} , H _{sb}) and of the installation hole (S _o , H _o)			double leaf (slab) door (without stop post) dimensions on the external side of leaves (S _{sb} , H _{sb}) and of the installation hole (S _o , H _o)		
type	S _{sb}	S _o	type	S _{sb}	S _o
"60"	644	620	"60"+"60"	1288	1240
"70"	744	720	"70"+"70"	1488	1440
"80"	844	820	"80"+"80"	1688	1640
"90"	944	920	"90"+"90"	1888	1840
"100"	1044	1020			

HEIGHT

H _o	H _{sb}	H _m
2020	2033	2138

WIDTH

single leaf (slab) door dimensions on the external side of leaves (S _{sb} , H _{sb}) and of the installation hole (S _o , H _o)				double leaf (slab) door (without stop post) dimensions on the external side of leaves (S _{sb} , H _{sb}) and of the installation hole (S _o , H _o)			
type	S _{sb}	S _o	S _d	type	S _{sb}	S _o	S _d
"60"	644	670	649	"60"+"60"	1288	1305	1282
"70"	744	770	749	"70"+"70"	1488	1505	1482
"80"	844	870	849	"80"+"80"	1688	1705	1682
"90"	944	970	949	"90"+"90"	1888	1905	1882
"100"	1044	1070	1049				

HEIGHT

H _o	H _d	H _{sb}	H _m
2055	2044	2033	2138

SLIDING system ON-WALL PREMIUM

EQUIPMENT ON-WALL PREMIUM SYSTEM

standard:
longitudinal pull handle in the colour
of chrome-satin (U4) p. 163

optional:
pull handles for sliding leaves p. 163

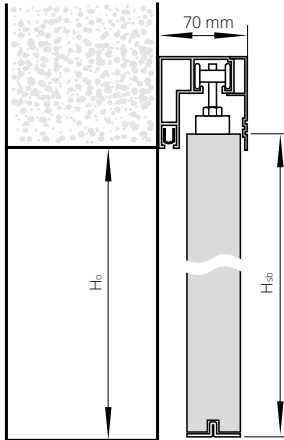

LENGTHS OF MASKING STRIPS FOR THE ON-WALL PREMIUM SYSTEM

"60"	1800 mm
"70"	1800 mm
"80"	1800 mm
"90"	2000 mm
"60"+"60"	1800 + 1800 mm
"70"+"70"	1800 + 1800 mm
"80"+"80"	1800 + 1800 mm
"90"+"90"	2000 + 2000 mm

Hm - door frame external height of the masking strip
Ho - installation hole height
Hsb - door leaf (slab) external height
Hd - door frame external height
So - installation hole width
Ssb - door leaf (slab) external width
Sd - door frame external width

WIDTH

single leaf (slab) door dimensions on the external side of leaves (Ssb, Hsb) and of the installation hole (So, Ho)			double leaf (slab) door dimensions on the external side of leaves (Ssb, Hsb) and of the installation hole (So, Ho)		
type	S _{sb}	S _o	type	S _{sb}	S _o
"60"	644	620	"60"+"60"	1288	1240
"70"	744	720	"70"+"70"	1488	1440
"80"	844	820	"80"+"80"	1688	1640
"90"	944	920	"90"+"90"	1888	1840

height: (Hsb) 2033, (Ho) 2020, height from the floor level to the masking strip top edge - 2103 mm



door in the SLIDING ON-WALL PREMIUM system

SLIDING system ON-WALL MOVI



Leaf (slab) STRUCTURE

Non-rebated system door leaf (slab). The door is made of a **wooden rail and stile set** topped with two plain HDF boards with the ECO TOP, LAMISTONE CPL and SILKSTONE surface, laminated, veneered and painted.

The standard in-fill is a honeycomb-like layer.
The rated door leaf (slab) thickness is 40 mm.

DOOR Leaf (slab) FINISH

Smooth painted, veneered, laminated surfaces or with ECO TOP, LAMISTONE CPL, SILKSTONE finishes.

ACCESSORIES

Standard equipment:

long brass pull handle chrome satin (U4)

Auxiliary equipment:

perforated chipboard in-fill

leaf (slab) lower by 50 mm

leaf (slab) higher by 50 mm

leaf (slab) higher by 100 mm

leaf (slab) higher by 150 mm

leaf (slab) higher by 200 mm



The tunnel system installation is not available for the MOVI sliding system.

Complete MOVI system price = MOVI leaf (slab) price
+ MOVI sliding system price

SLIDING ON-WALL MOVI SYSTEM

leaf (slab) width
"70" - "100"
"110"

LEAF (SLAB) FOR MOVI SLIDING SYSTEM

single leaf (slab) door	ECO TOP	UNI MAT PLUS	LAMISTONE CPL	laminated CPL 0,2 mm	PAINTED white	PAINTED grey, beige	BLACK black, sage	VENEERED			ESPINA	
			SILKSTONE					GROUP A	GROUP B	GROUP C	GROUP A	GROUP B
								"70" - "90"				
								"100" - "110"				

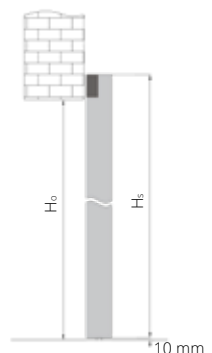
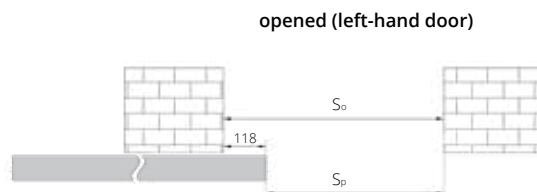
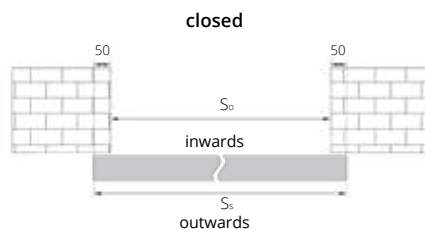

WIDTH				HEIGHT		
size	S _S	S _O	S _D	size	H _S	H _O
"70"	744	644	526	leaf (slab) lower by 50 mm	2040	1980
"80"	844	744	626	leaf (slab) standard	2090	2030
"90"	944	844	726	leaf (slab) higher by 50 mm	2140	2080
"100"	1044	944	826	leaf (slab) higher by 100 mm	2190	2130
"110"	1144	1044	926	leaf (slab) higher by 150 mm	2240	2180
				leaf (slab) higher by 200 mm	2290	2230

S_s - door leaf (slab) width
S_o - door frame installation hole width
S_p - clear opening width
H_o - installation hole height
H_s - door leaf (slab) height

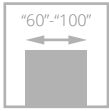

GALIO



GALIO door, S5 version, steel angle bracket door frame

Internal doors for use in public utility buildings such as offices as well as for residential units.
Internal doors manufactured in accordance with PN-EN 14351-2:2018.



double-sided angle bracket



hinge



GALIO door, S6 version, steel angle bracket door frame

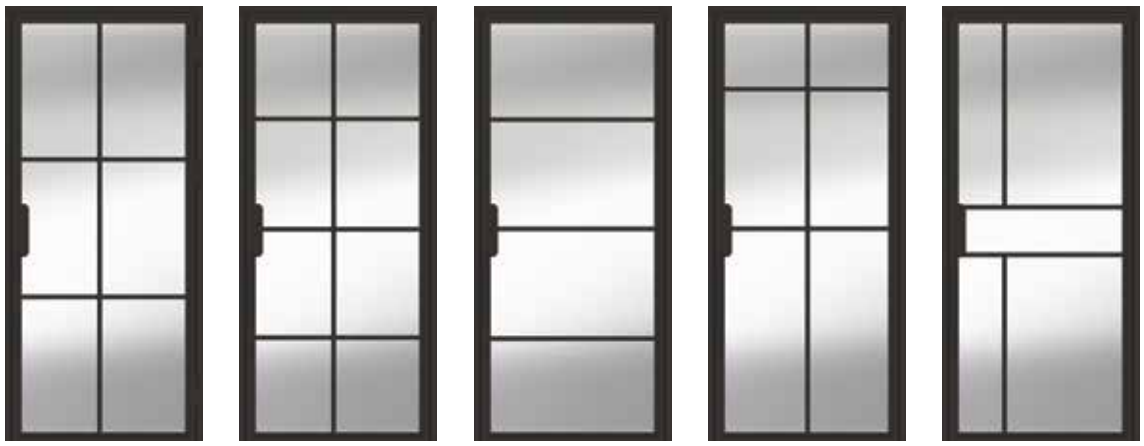

VERSION S1 / VS1 S2 / VS2 S3 / VS3 S4 / VS4 S5 / VS5



VERSION S6 / VS6 S7 / VS7 S8 / VS8 S9 / VS9

COLOURS

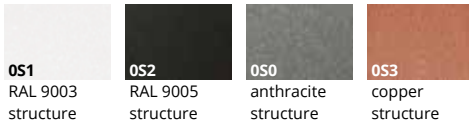

DOOR FRAMES

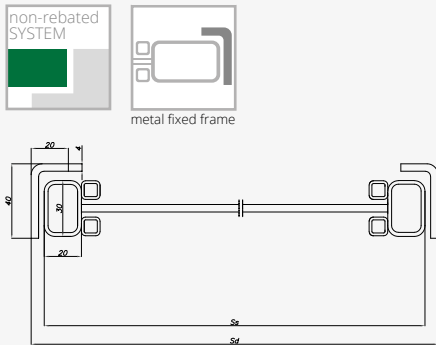

single leaf (slab) door				double leaf (slab) door			
type	S _s	S _d	S _o	type	S _s	S _d	S _o
„60”	625	639	642	„60”+„60”			
„70”	725	739	742	„70”+„70”			
„80”	825	839	842	„80”+„80”			
„90”	925	939	942	„90”+„90”			
„100”	1025	1039	1042	„100”+„100”			
H _s - 2040 mm, H _d - 2057 mm, H _o - 2060 mm							
- 50 mm height - H _s - 1990 mm, H _d - 2007 mm, H _o - 2010 mm							
+ 50 mm height - H _s - 2090 mm, H _d - 2107 mm, H _o - 2110 mm							
+ 100 mm height - H _s - 2140 mm, H _d - 2157 mm, H _o - 2160 mm							

EQUIPMENT

STANDARD
door leaf (slab) frame made of top-quality powder-coated steel profiles, metal muntin bars
structural powder paint, structural metal muntin bars
tempered transparent or satin white glass, 4 mm thick
frosted glass on the hinge side
constructional muntins 20 mm wide
double-sided angle bracket in the same colour as the leaf (slab)
leaf (slab) closing magnet
steel angle bracket door frame
metal frame hinges ("60"- "100" - 3 pcs.)
GALIO maximum door height - 2157 mm
ADDITIONAL (available at an extra charge)
colour 0S3 copper structure
doors with non-standard dimensions
door higher or lower by 50 mm

door higher or lower by 50 mm (non-standard height)			
door higher by 100 mm			
door higher by 50-100 mm (non-standard height)			
non-standard width dimensions			
GALIO colours	colour of hinges	colour of glazing gasket (muntin bars)	colour of frame screws
0S1 RAL 9003 (white)	in the colour of the door leaf (slab)	white	white
0S2 RAL 9005 (black)	in the colour of the door leaf (slab)	black	black
0S0 anthracite	in the colour of the door leaf (slab)	anthracite	black
0S3 copper	in the colour of the door leaf (slab)	black	black

Doors with non-standard dimensions can be manufactured after consultation with the Sales Department.

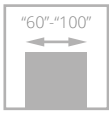

STALIO



STALIO door, S1 version, steel angle bracket door frame

Internal doors for use in public utility buildings such as offices as well as for residential units. Internal doors manufactured in accordance with PN-EN 14351-2:2018



lock with handle



hinge



STALIO door, S5 version, steel angle bracket door frame



VERSION S1 / VS1 S2 / VS2 S3 / VS3 S4 / VS4 S5 / VS5

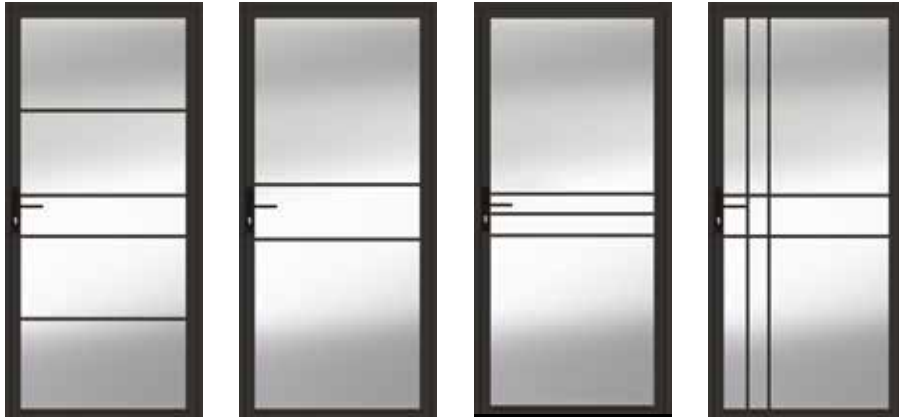

VERSION S6 / VS6 S7 / VS7 S8 / VS8 S9 / VS9

COLOURS

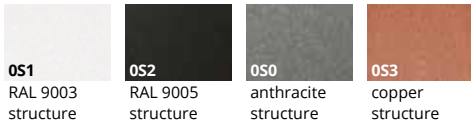

DOOR FRAMES

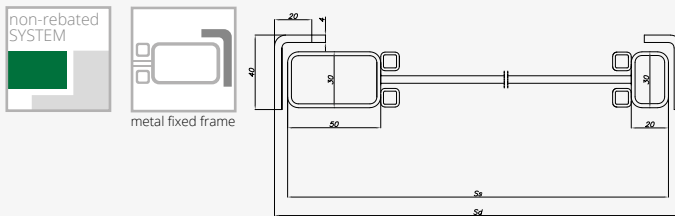

DIMENSIONS

WIDTH	Ss	Sd	So
"60"	625	643	646
"70"	725	743	746
"80"	825	843	846
"90"	925	943	946
"100"	1025	1043	1046
Hs - 2040 mm, Hd - 2057 mm, Ho - 2060 mm			
- 50 mm height - Hs - 1990 mm, Hd - 2007 mm, Ho - 2010 mm			
+ 50 mm height - Hs - 2090 mm, Hd - 2107 mm, Ho - 2110 mm			
+ 100 mm height - Hs - 2140 mm, Hd - 2157 mm, Ho - 2160 mm			

EQUIPMENT

STANDARD
door leaf (slab) frame made of top-quality powder-coated steel profiles, metal muntin bars
structural powder paint, structural metal muntin bars
tempered transparent or satin white glass, 4 mm thick
frosted glass on the hinge side
constructional muntins 20 mm wide
lock with handle
steel angle bracket door frame
metal frame hinges ("60"- "100" - 3 pcs.)
STALIO maximum door height - 2157 mm
ADDITIONAL (available at an extra charge)
colour OS3 copper structure
doors with non-standard dimensions
cylinder in the colour of silver

STALIO colours	colour of hinges	colour of glazing gasket (muntin bars)	colour of handle	colour of lock plate	colour of frame screws
OS1 RAL 9003 (white)	in the colour of the door leaf (slab)	white	white	silver	white
OS2 RAL 9005 (black)	in the colour of the door leaf (slab)	black	black	black	black
OS0 anthracite	in the colour of the door leaf (slab)	anthracite	black	black	black
OS3 copper	in the colour of the door leaf (slab)	black	black	black	black

Doors with non-standard dimensions can be manufactured after consultation with the Sales Department.

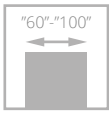

LUMEN



LUMEN door, I version, LUMEN adjustable door frame

The door is constructed of a tempered glass pane suspended on the adjustable LUMEN door frame available with a full range of colours: ECO TOP, LAMISTONE CPL, SILKSTONE, laminated and veneered.



handle



hinge



LUMEN door, I version, LUMEN adjustable door frame

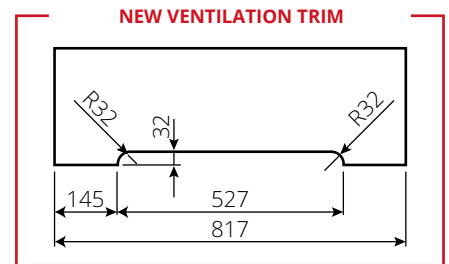

VERSION I

width "60" – "80"

width "90"

width "100"

LUMEN ADJUSTABLE DOOR FRAME (ZL)



WIDTH				
single leaf (slab) door				
type	S _o	S _d	S _s	S _{op}
"60"	676	646	617	746
"70"	776	746	717	846
"80"	876	846	817	946
"90"	976	946	917	1046
"100"	1076	1046	1017	1146

HEIGHT				
	H _o	H _d	H _s	H _{op}
	2053	2043	2016	2093

S_s, H_s - door leaf (slab) dimensions
 S_d, H_d - door dimensions on the door frame external side
 S_o, H_o - recommended installation dimension
 S_{op} - architrave external width

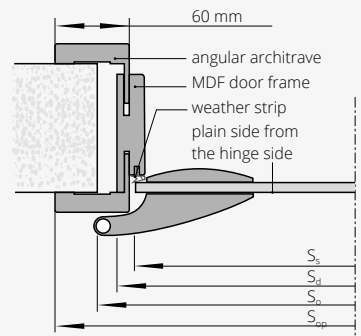

LUMEN	ECO TOP	UNI MAT PLUS	for the laminated type			PAINTED* white	PAINTED* grey, beige	BLACK black, sage	VENEERED		
			HIGH TOP	LAMISTONE CPL	SILKSTONE				GROUP A	GROUP B	GROUP C
adjustment range (mm) ZL 75-300											

*Lumen door frame in the PAINTING colour palette is only available with an 80 mm architrave
 Architraves interconnected at 90° are not available.

EQUIPMENT

STANDARD
tempered white/brown/graphite satin or transparent 8 mm thick glass
ornament on the side opposite to the hinges
height of handle for the glass pane standard height – 1040 mm from the glass pane bottom edge
ADDITIONAL (available at an extra charge)
fixed and adjustable metal frame
ventilation trim (p. 159)
glass pane with a non-standard height 1967 mm
electric strike in NC version JiS type 1710 12-24 V AC/DC (including a catch plate and a cut for the electric strike)
electric strike in NC version BIRA HARTE XS12U 12V AC/DC (including a catch plate and a cut for the electric strike)
electric strike in NC version with switch BIRA HARTE XS12UW 12V AC/DC (including a catch plate and a cut for the electric strike)
electric strike in NO version BIRA HARTE XS12R 12V DC (including a catch plate and a cut for the electric strike)
DORMA hardware

DORMA hardware	aluminium EV1-Deco 114	aluminium stainless steel 107	black **
	handle + lock + hinges		
	handle + WB + hinges		
	handle + WC + hinges		
	knob type handle + small lock + hinges*		

* ref. to the door plus electric strike set
 ** bottom hinges leaf (slab) is with cpas, top hinges leaf (slab) is painted black
 WB – cylinder type
 WC – bathroom privacy lock type

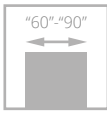

LUMEN LOFT

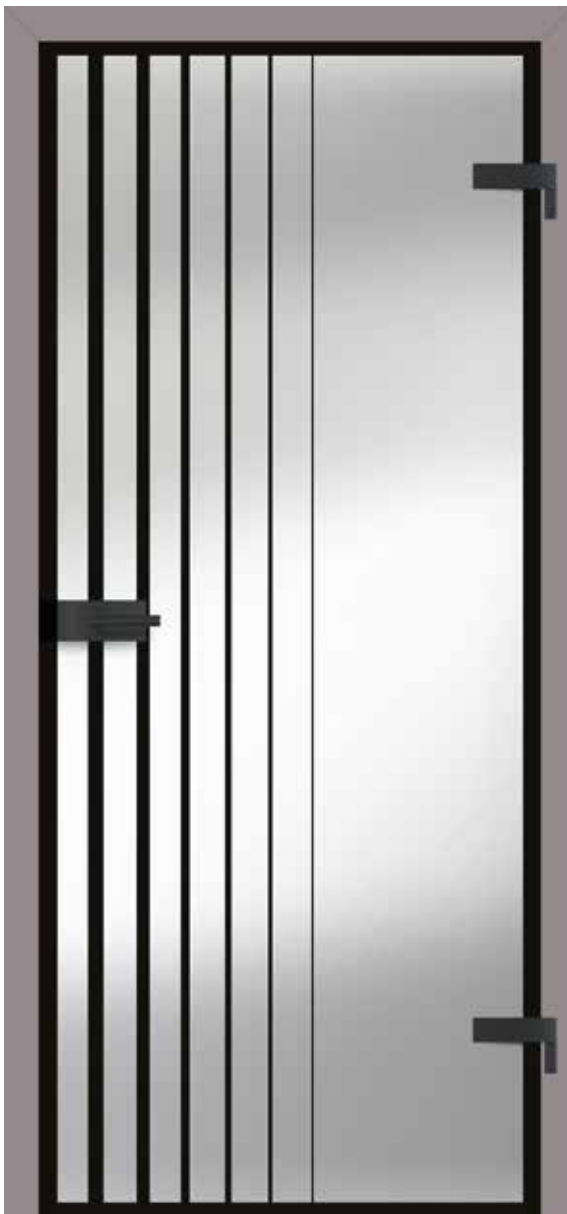

LUMEN LOFT door, V4 version, LUMEN adjustable door frame

- **tempered 8 mm thick glass**
- **decor in the colour of black or white**

The door is constructed of a tempered glass pane suspended on the adjustable LUMEN door frame available with a full range of colours: ECO TOP, LAMISTONE CPL, SILKSTONE, laminated and veneered.



handle



hinge



LUMEN LOFT door, V2 version, LUMEN adjustable door frame



VERSION	V1	V2	V3	V4
		"60" - "80"		"90"

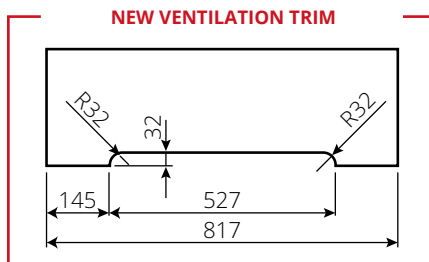

DOOR FRAMES

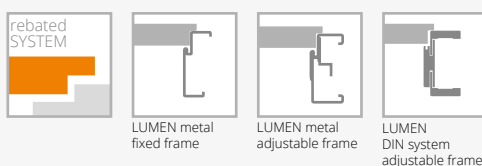

detailed dimensions of the LUMEN adjustable frame - p. 125

EQUIPMENT

STANDARD
8 mm thick, toughened glass with a single black or white screen-printed decoration
height of handle for the glass pane standard height - 1040 mm from the glass pane bottom edge
ADDITIONAL (available at an extra charge)
fixed and adjustable metal frame
ventilation trim
electric strike in NC version JIS type 1710 12-24 V AC/DC (including a catch plate and a cut for the electric strike)
electric strike in NC version BIRA HARTE XS12U 12V AC/DC (including a catch plate and a cut for the electric strike)
electric strike in NC version with switch BIRA HARTE XS12UW 12V AC/DC (including a catch plate and a cut for the electric strike)
electric strike in NO version BIRA HARTE XS12R 12V DC (including a catch plate and a cut for the electric strike)
DORMA hardware

DORMA hardware			
	aluminium EV1-Deco 114	aluminium stainless steel 107	black **
handle + lock + hinges			
handle + WB + hinges			
handle + WC + hinges			
knob type handle + small lock + hinges*			

* ref. to the door plus electric strike set
 ** bottom hinges leaf (slab) is with cpas, top hinges leaf (slab) is painted black

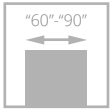

FOLDING



Door leaf (slab) constructed of a **wooden rail and stile set** topped with two plain laminated, veneered HDF boards. The standard in-fill is a honeycomb-like layer.



FOLDING door, 00 version, SYSTEM DIN DUO adjustable door frame

pull handle



FOLDING door, 00 version, DIN DUO adjustable door frame

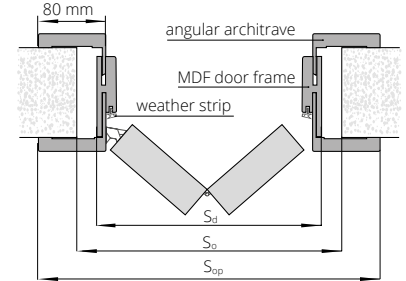

VERSION **00 / V00** **00 / V00 double leaf (slab) door**

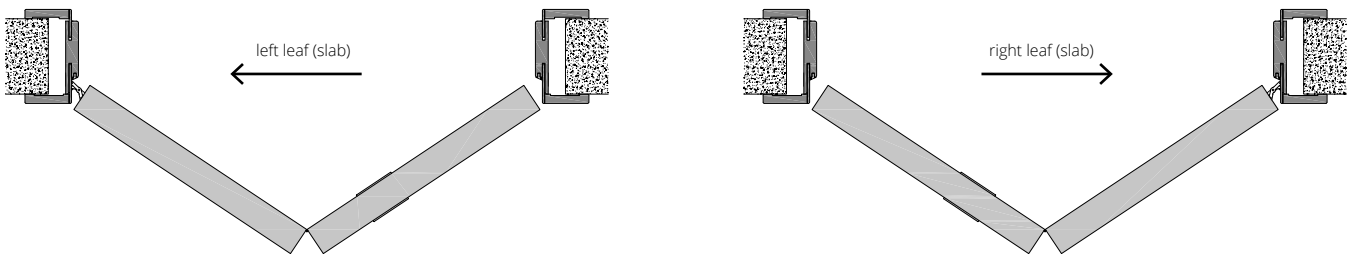

COLOURS

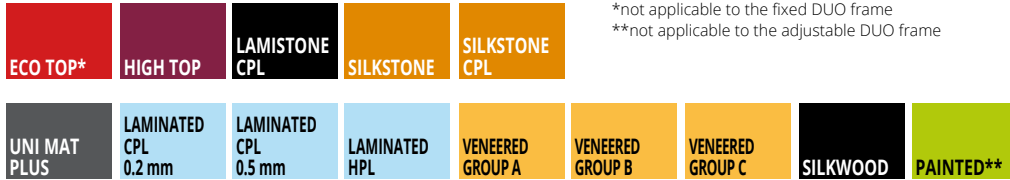

*not applicable to the fixed DUO frame
 **not applicable to the adjustable DUO frame

DOOR FRAMES



Folding door DIN DUO door frame							
single leaf (slab) door				double leaf (slab) door			
type	S _o	S _d	S _{op}	type	S _o	S _d	S _{op}
"60"	690	652	792	"60"+"60"	1305	1267	1407
"70"	790	752	892	"70"+"70"	1505	1467	1607
"80"	890	852	992	"80"+"80"	1705	1667	1807
"90"	990	952	1092	"90"+"90"	1905	1867	2007
HEIGHT	H _o		H _d		H _s		H _{op}
	2085		2079		2040		2133

Folding door DUO wooden fixed door frame					
single leaf (slab) door			double leaf (slab) door		
type	S _o	S _d	type	S _o	S _d
"60"	713	693	"60"+"60"	1328	1308
"70"	813	793	"70"+"70"	1528	1508
"80"	913	893	"80"+"80"	1728	1708
"90"	1013	993	"90"+"90"	1928	1908
HEIGHT	H _o		H _d		H _s
	2093		2083		2040

Folding door DUO wooden adjustable door frame							
single leaf (slab) door				double leaf (slab) door			
type	S _o	S _d	S _{op}	type	S _o	S _d	S _{op}
"60"	713	693	836	"60"+"60"	1328	1308	1451
"70"	813	793	936	"70"+"70"	1528	1508	1651
"80"	913	893	1036	"80"+"80"	1728	1708	1851
"90"	1013	993	1136	"90"+"90"	1928	1908	2051
HEIGHT	H _o		H _d		H _s		H _{op}
	2093		2083		2040		2154

H_s - door leaf (slab) height
 S_d, H_d - door dimensions on the door frame external side
 S_o, H_o - recommended installation dimension
 S_{op}, H_{op} - architrave external dimension

EQUIPMENT

STANDARD
guide rail and concealed adjustable hinges in the door leaf (slab)
adjustable concealed hinges "60" - "80" - 2 pcs; "90" - 3 pcs
round plastic pull handle
ADDITIONAL (available at an extra charge)
perforated chipboard in-fill
solid chipboard in-fill (third hinge recommended)

door lower by 55 mm
door higher by 50 mm, 100 mm
door higher by 150 mm, 200 mm
third hinge concealed in the door leaf (slab) DUO for "60"- "80" widths
single-point mortise lock, WB hook type (one leaf (slab) door only)
pull handles for folding door leaves

SOUNDPROOF

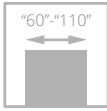

SOUNDPROOF door, 00 version, SYSTEM DIN adjustable door frame

Single leaf (slab) **SOUNDPROOF** door in the rebated system. The leaf (slab) structure consists of a **rail and stile set made of coniferous wood**, topped with HDF boards on both sides. The in-fill is made of solid chipboard (type A) or the special POL-SKONE structure (type B). Leaf (slab) with a drop down seal.

acoustic insulation:
 with a wooden door frame:
class Rw=27 dB (type A); class Rw=32 dB (type B)
 with a metal door frame:
class Rw=27 dB (type A); class Rw=37 dB (type B)
 with the DIN adjustable door frame:
class Rw=27 dB (type A); class Rw=37 dB (type B)
ITB technical approval: ITB-KOT-2021/2041

Single or double leaf (slab) **SOUNDPROOF DUO** non-rebated door. The leaf (slab) structure consists of a **rail and stile set made of coniferous wood**, topped with HDF boards on both sides. The in-fill is made of solid chipboard (type A) or the special POL-SKONE structure (type B). **The door is available in the single and double leaf (slab) version with a wooden frame (DUO fixed or DUO adjustable).** Leaf (slab) with a drop down seal.

acoustic insulation:
 single and double leaf (slab) door type A – **class Rw=27 dB**
 single leaf (slab) type B – **class Rw=37 dB**
 double leaf (slab) type B – **class Rw=32 dB**
 mechanical class: mechanical resistance requirements class 2,
 i.e. average service conditions
ITB technical approval: ITB-KOT-2021/2041



handle, lock



standard interconnection of architraves at the 45° angle



SOUNDPROOF door, 00 version, SYSTEM DIN adjustable door frame



VERSION 00 / V00

COLOURS



DOOR FRAMES

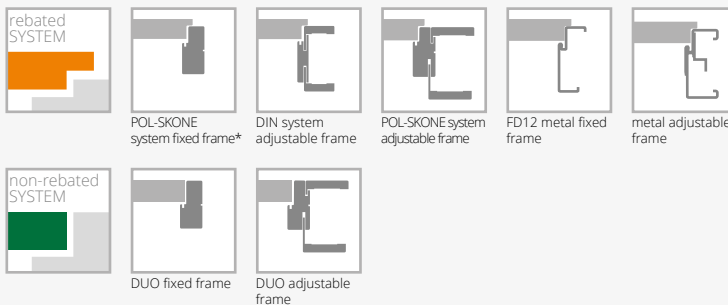

*not applicable to the ECO TOP surface finish

EQUIPMENT

SOUNDPROOF

STANDARD
single-point key-operated or cylinder type mortise lock spacing 72 mm
adjustable pivot hinges - 3 pcs
in case of door leaf (slab) with door closer and DIN system or metal frame to be used T type hinges ("60"- "80" - 3 pcs, "90" - 4 pcs) - replacement of standard hinges with hinge type T for an extra charge
drop seal
standard width: "80", "90"
ADDITIONAL (available at an extra charge)
size "100"
size "110"
antipanic lever
surface mounted door closer
reinforcement for door closer
electronic locks
electric door strike (reverse or averse action)
decors (Type B version not available with intarsia)
plates with access control systems
door higher by 50 mm or 100 mm
door higher by 150 mm or 200 mm
door higher by 250 mm or 300 mm
(not applicable to the DIN system door frames)
door higher by 350 mm or 400 mm
(not applicable to the DIN system door frames)

DUO SOUNDPROOF

STANDARD
concealed hinge (adjustable in 3 planes)
("60" - "70" - 2 pcs; "80" - "90" - 3 pcs)
lock:
single leaf (slab) door - key-operated or cylinder type magnetic lock spacing 85 mm
double leaf (slab) door - key-operated or cylinder type latch lock, 72 mm
drop seal
ADDITIONAL (available at an extra charge)
surface-mounted or concealed door closer
additional mortise or surface-mounted lock
surface-mounted electromagnetic coils by: ASSA ABLOY, DORMA or GEZE
peephole
door higher by 50 mm or 100 mm
door higher by 150 mm or 200 mm
door higher by 250 mm or 300 mm
door higher by 350 mm or 400 mm

p. 163

MDF FIXED door frame

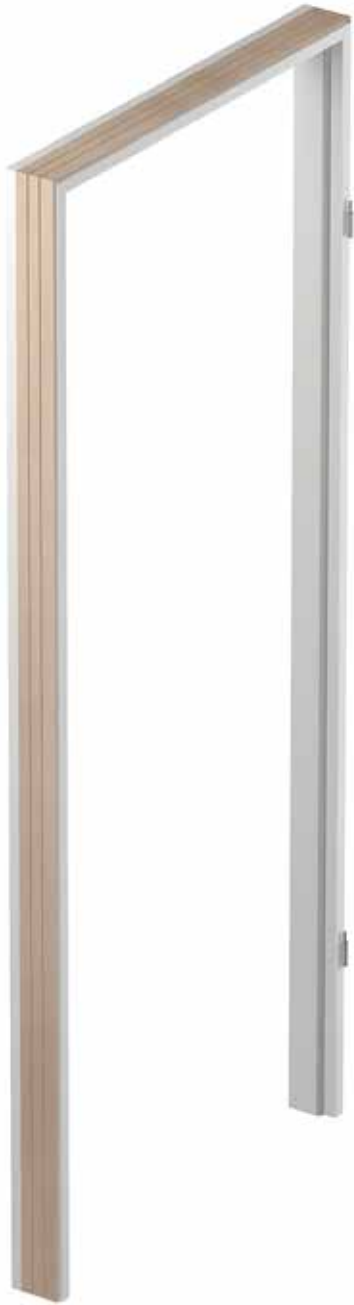

single leaf (slab) door

ECO TOP

EXTRA CHARGES

double leaf (slab) type

door frame lower by 50 mm or 100 mm

"100"

"110"

OPTION

LD6 masking strips (available at an extra charge)

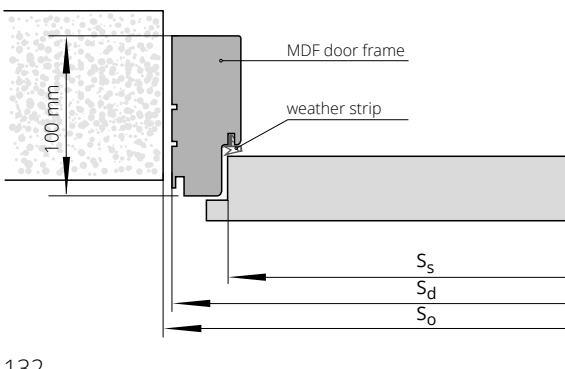

WIDTH

single leaf (slab) door			double leaf (slab) door			
type	S _o	S _d	S _s	type	S _o	S _d
"60"	709	689	618	"60"+"60"	1343	1323
"70"	809	789	718	"60"+"70"	1443	1423
"80"	909	889	818	"60"+"80", "70"+"70"	1543	1523
"90"	1009	989	918	"60"+"90", "70"+"80"	1643	1623
				"70"+"90", "80"+"80"	1743	1723
				"80"+"90"	1843	1823
				"90"+"90"	1943	1923

HEIGHT

H _o	H _d	H _s
2074	2064	2020

S_s - door leaf (slab) width
S_d - door frame external width
S_o - installation hole width

H_s - door leaf (slab) height
H_d - door frame external height
H_o - installation hole height

POL-SKONE FIXED door frame



for the laminated type			VENEERED		
HIGH TOP	PAINTED* white	PAINTED* grey, beige	GROUP A	GROUP B	GROUP C, D
UNI MAT PLUS					
LAMISTONE CPL					
SILKSTONE					

EXTRA CHARGES

door frame lower by 50 mm or 100 mm

door frame higher by 50 mm or 100 mm

door frame higher by 150 mm or 200 mm

"100"

"110"

electric strike in NC version JiS typ 1710 12-24 V AC/DC (including a catch plate and a cut for the electric strike)**

electric strike in NC version BIRA HARTE XS narrow XS12U 12V AC/DC (including a plate and a cut for the electric strike)**

electric strike in NC version with switch BIRA HARTE XS12UW 12V AC/DC (including a catch plate and a cut for the electric strike)**

electric strike in NO version BIRA HARTE XS narrow XS12R 12V DC (including a catch plate and a cut for the electric strike)**

OPTION

LD6 masking strip (available at an extra charge)

*environment-friendly acrylic paints, RAL and NCS colours (except metallic ones)

- available at an extra charge according to the colour groups (p. 10)

** for leaves equipped with the ECO Schulte GBS 12 lock - extra charge

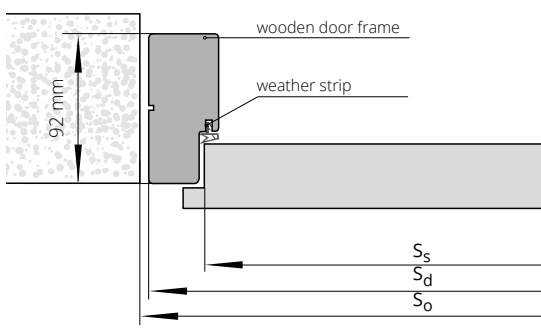

WIDTH

type	single leaf (slab) door			double leaf (slab) door		
	S _o	S _d	S _s	type	S _o	S _d
"60"	709	689	618	"60"+"60"	1343	1323
"70"	809	789	718	"60"+"70"	1443	1423
"80"	909	889	818	"60"+"80", "70"+"70"	1543	1523
"90"	1009	989	918	"60"+"90", "70"+"80"	1643	1623
"90 plus"	1019	999	928	"70"+"90", "80"+"80"	1743	1723
				"80"+"90"	1843	1823
				"90"+"90"	1943	1923

HEIGHT

H _o	H _d	H _s
2074	2064	2020

S_s - door leaf (slab) width
S_d - door frame external width
S_o - installation hole width

H_s - door leaf (slab) height
H_d - door frame external height
H_o - installation hole height



DIN SYSTEM ADJUSTABLE door frame



single leaf (slab) door	ECO TOP	HIGH TOP	PAINTED* white
		LAMISTONE CPL	
		SILKSTONE	
		UNI MAT PLUS	
			for the laminated type
ZP, range in mm 75-300			

single leaf (slab) door	PAINTED* grey, beige	VENEERED			BLACK black, sage
		GROUP A	GROUP B	GROUP C, D	
ZP, range in mm 75-300					

EXTRA CHARGES

double leaf (slab) type
door frame lower by 50 mm or 100 mm
door frame higher by 50 mm or 100 mm
door frame higher by 150 mm or 200 mm
"100"
"110"
architraves interconnected at the 90° angle (applies to B 90° and C 90° architraves version)
architraves with a width of 80 mm
electric strike in NC version JiS typ 1710 12-24 V AC/DC (including a catch plate and a cut for the electric strike)**
electric strike in NC version BIRA HARTE XS narrow XS12U 12V AC/DC (including a plate and a cut for the electric strike)**
electric strike in NC version with switch XS12UW 12V AC/DC (including a catch plate and a cut for the electric strike)**
electric strike in NO version BIRA HARTE XS narrow XS12R 12V DC (including a catch plate and a cut for the electric strike)**
reinforcement for the arm/guide rail door closer***
replacement of the B type hinge with the K type hinge
three-part T type hinge
crown

p. 157

new way of architraves interconnected - p. 12

Version A: 60 mm (not applicable to the painted door)
Version B: 80 mm

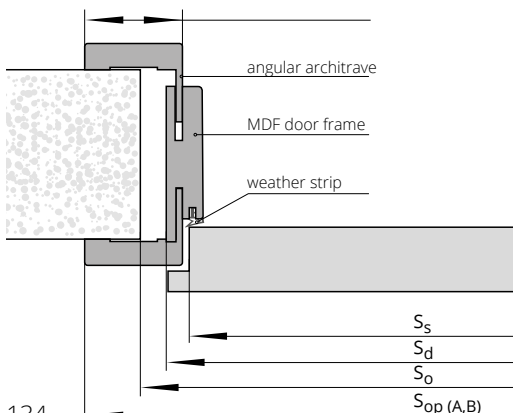

Door frames with ranges wider than the maximum ones provided in the table above are available (upon consultation with the Sales Department).

*environment-friendly acrylic paints, RAL and NCS colours (except metallic ones)

- available at an extra charge according to the colour groups (p. 10).

** for leaves equipped with the ECO Schulte GBS 12 - extra charge, the installation hole width increased by 15 mm

***NOTE! The recommended dimension of the installation hole height increased by 16 mm.

WIDTH														
single leaf (slab) door								double leaf (slab) door						
type	So	Sd	Ss	SopA	SopAF	SopB	SopBF	type	So	Sd	SopA	SopAF	SopB	SopBF
"60"	676	646	618	746	748	786	788	"60"+"60"	1310	1280	1380	1382	1420	1422
"70"	776	746	718	846	848	886	888	"60"+"70"	1410	1380	1480	1482	1520	1522
"80"	876	846	818	946	948	986	988	"60"+"80","70"+"70"	1510	1480	1580	1582	1620	1622
"90"	976	946	918	1046	1048	1086	1088	"60"+"90","70"+"80"	1610	1580	1680	1682	1720	1722
"90 plus"	986	956	928	1056	1058	1096	1098	"70"+"90","80"+"80"	1710	1680	1780	1782	1820	1822
								"80"+"90"	1810	1780	1880	1882	1920	1922
								"90"+"90"	1910	1880	1980	1982	2020	2022

HEIGHT					
	H _o	H _d	H _s	H _{opA}	H _{opB}
	2053	2043	2020	2093	2113

Ss - door leaf (slab) width
Sd - door frame external width
So - installation hole width
Sop - architrave external width
SopAF - dimension for veneered door frame
SopBF - dimension for veneered door frame
SopA - dimension for laminated and painted door frame
SopB - dimension for laminated and painted door frame

Hs - door leaf (slab) height
Hd - door frame external height
Ho - installation hole height
Hop - architrave external height

AQUA DIN ADJUSTABLE door frame



single leaf (slab) door	ECO TOP	HIGH TOP	PAINTED white 001	PAINTED grey, beige	BLACK black, sage	VENEERED		
		LAMISTONE CPL				VENEERED GROUP A	VENEERED GROUP B	VENEERED GROUP C
		SILKSTONE						
		UNI MAT PLUS						
	for the laminated type							

ZP, range in mm 75-300

architraves interconnected at the 45° angle

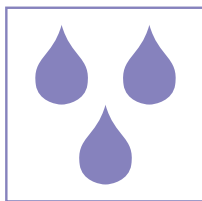

door frame made of high quality MDF board characterized by high resistance to moisture

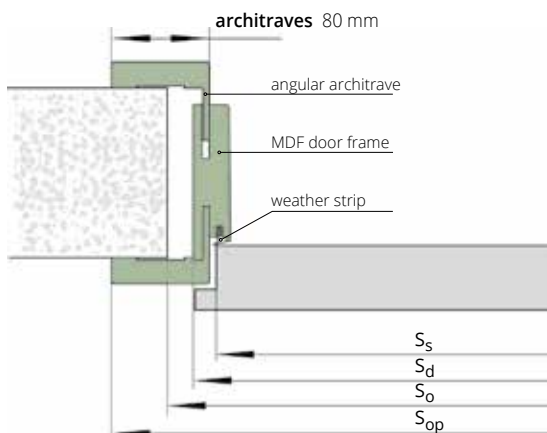

WIDTH

type	single leaf (slab) door					double leaf (slab) door				
	So	Sd	Ss	SopB	SopF	type	So	Sd	SopB	SopF
"60"	676	646	618	786	788	"60"+"60"	1310	1280	1420	1422
"70"	776	746	718	886	888	"60"+"70"	1410	1380	1520	1522
"80"	876	846	818	986	988	"60"+"70", "70"+"70"	1510	1480	1620	1622
"90"	976	946	918	1086	1088	"60"+"90", "70"+"80"	1610	1580	1720	1722
"90 plus"	986	956	928	1096	1098	"70"+"90", "80"+"80"	1710	1680	1820	1822
						"80"+"90"	1810	1780	1920	1922
						"90"+"90"	1910	1880	2020	2022

HEIGHT

Ho	Hd	Hs	Hop
2053	2043	2020	2113

Ss - door leaf (slab) width
 Sd - door frame external width
 So - installation hole width
 Sop - architrave external width
 SopB - laminated or painted door frame width
 SopF - veneered door frame width

Hs - door leaf (slab) height
 Hd - door frame external height
 Ho - installation hole height
 Hop - architrave external height

POL-SKONE SYSTEM ADJUSTABLE door frame



single leaf (slab) door	HIGH TOP	VENEERED		
	UNI MAT PLUS			
	LAMISTONE CPL			
	SILKSTONE	GROUP A	GROUP B	GROUP C, D
	for the laminated type			

ZZ, range in mm 62-391

EXTRA CHARGES

door frame lower by 50 mm or 100 mm	
door frame higher by 50 mm or 100 mm	
door frame higher by 150 mm or 200 mm	
double leaf (slab) type	
"100"	
"110"	
electric strike in NC version JiS typ 1710 12-24 V AC/DC (including a catch plate and a cut for the electric strike)*	
electric strike in NC version BIRA HARTE XS narrow XS12U 12V AC/DC (including a plate and a cut for the electric strike)*	
electric strike in NC version with switch BIRA HARTE XS12UW 12V AC/DC (including a catch plate and a cut for the electric strike)*	
electric strike in NO version BIRA HARTE XS narrow XS12R 12V DC (including a catch plate and a cut for the electric strike)*	
crown	p. 157

Door frames with ranges wider than the maximum ones provided in the table above are available (upon consultation with the Sales Department).

* for leaves equipped with the ECO Schulte GBS 12 - extra charge, architraves are pre-milled to accommodate the electric door strike

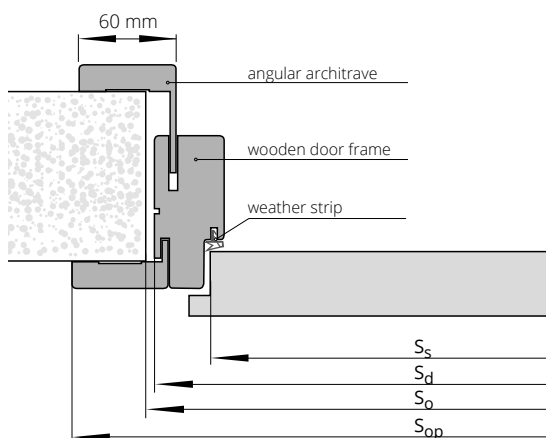

WIDTH									
single leaf (slab) door					double leaf (slab) door				
type	S _o	S _d	S _s	S _{op}	type	S _o	S _d	S _{op}	
"60"	715	695	618	798	"60"+"60"	1350	1330	1433	
"70"	815	795	718	898	"60"+"70"	1450	1430	1533	
"80"	915	895	818	998	"60"+"80", "70"+"70"	1550	1530	1633	
"90 plus"	1025	1005	928	1108	"60"+"90", "70"+"80"	1650	1630	1733	
					"70"+"90", "80"+"80"	1750	1730	1833	
					"80"+"90"	1850	1830	1933	
"90"+"90"	1950	1930	2033						

HEIGHT				
	H _o	H _d	H _s	H _{op}
	2077	2067	2020	2118

S_s - door leaf (slab) width
S_d - door frame external width
S_o - installation hole width
S_{op} - architrave external width

H_s - door leaf (slab) height
H_d - door frame external height
H_o - installation hole height
H_{op} - architrave external height



LUMEN METAL FIXED door frame



Dedicated for the LUMEN glass pane.
Door frame made of 1.5 mm thick sheet metal.

COLOURS

Powder-coated door frame.
Standard colours: white (RAL 9016), white (RAL 9003), grey (RAL 7047), brown (RAL 8014), beige (RAL 1001), graphite (RAL 7024), black (RAL 9005). Other RAL colours are available at an extra charge - upon consultation with the Sales Department (except the metallic and pearl ones)



single leaf (slab) door	
type	"60"÷"90"
FD12 LUMEN	

EXTRA CHARGES

compatible with the electric door strike
door frames in metallic colours (p. 11)
electric strike in NC version JiS typ 1710-12 AC (including a catch plate)
electric strike in NC version BIRA HARTE XS narrow XS12U 12V AC/DC (including a catch plate)
electric strike in NC version with switch BIRA HARTE XS narrow XS12UW 12V AC/DC (including a catch plate)
electric strike in NO version BIRA HARTE XS narrow XS12R 12V DC (including a catch plate)

The installation hole must be enlarged for door frames equipped with an electric strike by additional 5 mm.

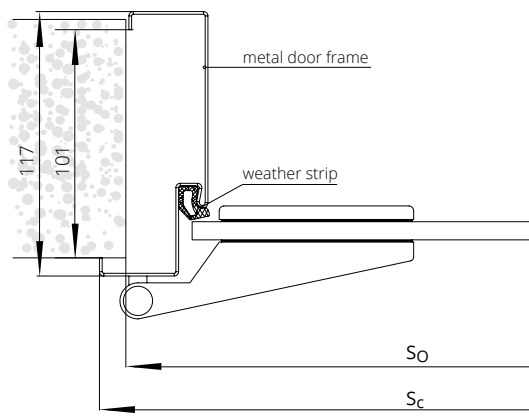

WIDTH FD12 LUMEN				
single leaf (slab) door				
type	S ₀	S _d	S _c	S _s
"60"	681	671	697	617
"70"	781	771	797	717
"80"	881	871	897	817
"90"	981	971	997	917

HEIGHT				
	H _d	H ₀	H _c	H _s
	2055	2060	2068	2017

S_s - door leaf (slab) width
S_d - door frame external width
S₀ - installation hole width
S_c - total door frame width

H_s - door leaf (slab) height
H_d - door frame external height
H₀ - installation hole height
H_c - total door frame height



LUMEN METAL ADJUSTABLE door frame



Dedicated for the LUMEN glass pane.
Door frame made of 1.5 mm thick sheet metal.

COLOURS

Powder-coated door frame.
Standard colours: white (RAL 9016), white (RAL 9003), grey (RAL 7047), brown (RAL 8014), beige (RAL 1001), graphite (RAL 7024), black (RAL 9005). Other RAL colours are available at an extra charge - upon consultation with the Sales Department (except the metallic and pearl ones)



single leaf (slab) door

ZO, range in mm 95-365

EXTRA CHARGES

additional ZOZ adjustment system for the rebated adjustable frame (wall width range increase 635 mm)

compatible with the electric door strike

door frames in metallic colours (p. 11)

electric strike in NC version JIS typ 1710-12 AC (including a catch plate)

electric strike in NC version BIRA HARTE XS narrow XS12U 12V AC/DC (including a catch plate)

electric strike in NC version with switch BIRA HARTE XS narrow XS12UW 12V AC/DC (including a catch plate)

electric strike in NO version BIRA HARTE XS narrow XS12R 12V DC (including a catch plate)

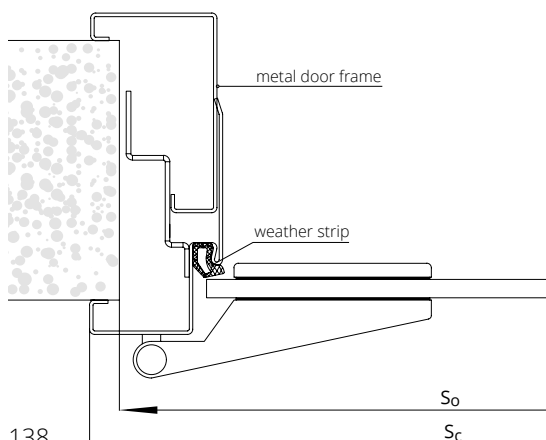

WIDTH FD61 LUMEN

single leaf (slab) door			
type	So	Sc	Ss
"60"	690	717	617
"70"	790	817	717
"80"	890	917	817
"90"	990	1017	917

HEIGHT

	Ho	Hc	Hs
	2065	2078	2017

Ss - door leaf (slab) width
So - installation hole width
Sc - total door frame width

Hs - door leaf (slab) height
Ho - installation hole height
Hc - total door frame height



POL-SKONE SYSTEM METAL DIAGONAL **FIXED** door frame



COLOURS

Powder-coated door frame.

Standard colours: white (RAL 9016), white (RAL 9003), grey (RAL 7047), brown (RAL 8014), beige (RAL 1001), graphite (RAL 7024), black (RAL 9005). Other RAL colours are available at an extra charge - upon consultation with the Sales Department (except the metallic and pearl ones)

single leaf (slab) door		double leaf (slab) door	
"60"÷"90"	"100" ÷ "110"	"120"÷"150"	"160"÷"200"
FD15 plate thickness: 1.5 mm			

EXTRA CHARGES

door frame lower by 50 mm or 100 mm
door frame higher by 50 mm
door frame higher by 100 mm
door frame higher by 150 mm
door frame higher by 200 mm
reinforcement for the surface mounted door closer
compatible with the electric door strike
door frames in metallic colours (p. 11)
electric strike in NC version JiS typ 1710-12 AC (including a catch plate)*
electric strike in NC version BIRA HARTE XS narrow XS12U 12V AC/DC (including a catch plate)*
electric strike in NC version with switch BIRA HARTE XS narrow XS12UW 12V AC/DC (including a catch plate)*
electric strike in NO version BIRA HARTE XS narrow XS12R 12V DC (including a catch plate)*
hinge M for the metal door frame (width "60"- "80")
replacement hinge with the T type hinge (width "60"- "80")

* for leaves equipped with the ECO Schulte GBS 12 - extra charge

Door frame made of the highest quality 1.5 mm thick steel plate.

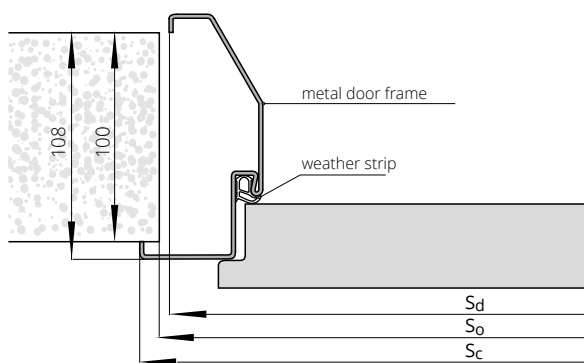

WIDTH			
type	single leaf (slab) door		
	S _o	S _d	S _c
"60"	700	691	717
"70"	800	791	817
"80"	900	891	917
"90"	1000	991	1017
"90" plus	1010	1001	1027
"100"	1100	1091	1117
"110"	1200	1191	1217

HEIGHT	H _o	H _c	H _d
	2069	2078	2065

S_o - installation hole width
S_d - door frame external width
S_c - total door frame width

H_o - installation hole height
H_d - door frame external height
H_c - total door frame height

POL-SKONE SYSTEM METAL DIAGONAL ADJUSTABLE door frame



COLOURS

Powder-coated door frame.
Standard colours: white (RAL 9016), white (RAL 9003), grey (RAL 7047), brown (RAL 8014), beige (RAL 1001), graphite (RAL 7024), black (RAL 9005). Other RAL colours are available at an extra charge - upon consultation with the Sales Department (except the metallic and pearl ones)

EXTRA CHARGES

single leaf (slab) door		double leaf (slab) door	
"60"÷"90"	"100" ÷ "110"	"120"÷"150"	"160"÷"200"
D0, range in mm 125-365			
door frame lower by 50 mm or 100 mm			
door frame higher by 50 mm			
door frame higher by 100 mm			
door frame higher by 150 mm			
door frame higher by 200 mm			
reinforcement for the surface mounted door closer			
compatible with the electric door strike			
door frames in metallic colours (p. 11)			
electric strike in NC version JiS typ 1710-12 AC (including a catch plate)*			
electric strike in NC version BIRA HARTE XS narrow XS12U 12V AC/DC (including a catch plate)*			
electric strike in NC version with switch BIRA HARTE XS narrow XS12UW 12V AC/DC (including a catch plate)*			
electric strike in NO version BIRA HARTE XS narrow XS12R 12V DC (including a catch plate)*			
hinge M for the metal door frame (width "60"- "80")			
replacement hinge with the T type hinge			

* for leaves equipped with the ECO Schulte GBS 12 - extra charge

Door frame made of the highest quality 1.5 mm thick steel plate.

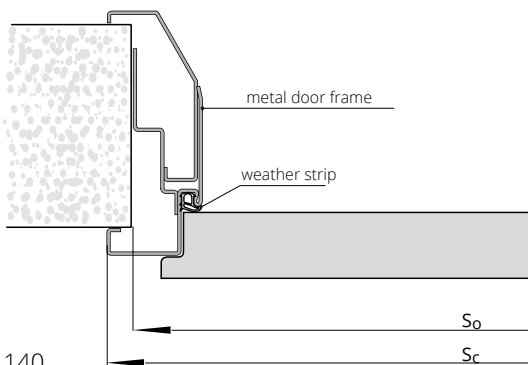

WIDTH		
single leaf (slab) door		
type	So	Sc
"60"	689	717
"70"	789	817
"80"	889	917
"90"	989	1017
"90" plus	999	1027
"100"	1089	1117
"110"	1189	1217

HEIGHT		
	Ho	Hc
	2065	2078

So - installation hole width
Sc - total door frame width

Ho - installation hole height
Hc - total door frame height



Approval no. AT-15-9775/2016

POL-SKONE SYSTEM METAL FIXED door frame

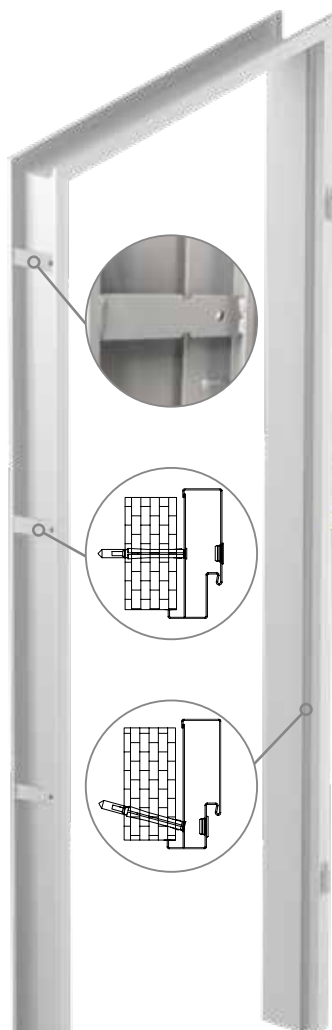

stainless steel threshold



COLOURS

Powder-coated door frame.
Standard colours: white (RAL 9016), white (RAL 9003), grey (RAL 7047), brown (RAL 8014), beige (RAL 1001), graphite (RAL 7024), black (RAL 9005). Other RAL colours are available at an extra charge - upon consultation with the Sales Department (except the metallic and pearl ones)

	single leaf (slab) door		double leaf (slab) door	
Door frame type	"60"÷"90"	"100" ÷ "110"	"120"÷"150"	"160"÷"200"
	FD14 small, FD12 big			

EXTRA CHARGES

door frame lower by 50 mm or 100 mm
door frame higher by 50 mm
door frame higher by 100 mm
door frame higher by 150 mm
door frame higher by 200 mm
stainless steel threshold for the FD12 door frame
reinforcement for the surface mounted door closer
compatible with the electric door strike
door frames in metallic colours (p. 11)
electric strike in NC version JIS typ 1710-12 AC (including a catch plate)*
electric strike in NC version BIRA HARTE XS narrow XS12U 12V AC/DC (including a catch plate)*
electric strike in NC version with switch BIRA HARTE XS narrow XS12UW 12V AC/DC (including a catch plate)*
electric strike in NO version BIRA HARTE XS narrow XS12R 12V DC (including a catch plate)*
hinge M for the metal door frame (width "60"-/80")
replacement hinge with the T type hinge

WIDTH FD14				WIDTH FD12			
single leaf (slab) door		double leaf (slab) door		single leaf (slab) door		double leaf (slab) door	
type	S _o	S _d	S _c	type	S _o	S _d	S _c
"60"	673	633	697	"120"	1307	1267	1331
"70"	773	733	797	"130"	1407	1367	1431
"80"	873	833	897	"140"	1507	1467	1531
"90"	973	933	997	"150"	1607	1567	1631
"90"plus	983	943	1007	"160"	1707	1667	1731
"100"	1073	1033	1097	"170"	1807	1767	1831
"110"	1173	1133	1197	"180"	1907	1867	1931
				"190"	2007	1967	2031
				"200"	2107	2067	2131

* for leaves equipped with the ECO Schulte GBS 12 - extra charge

The installation hole must be enlarged for door frames equipped with an electric strike: by 5 mm for FD12, by 10 mm for FD14.

Door frame made of the highest quality 1.5 mm thick steel plate (FD12) and 1.5 mm thick (FD14).

HEIGHT	H _d	H _o	H _c	HEIGHT	H _d	H _o	H _c
	2036	2046	2068		2055	2060	2068

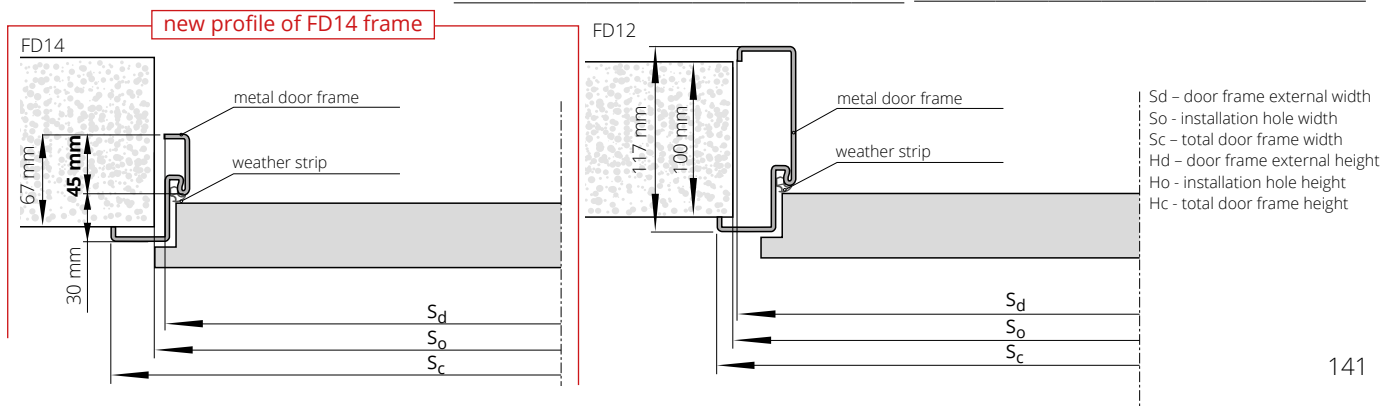

POL-SKONE SYSTEM METAL ADJUSTABLE door frame



COLOURS

Powder-coated door frame.
Standard colours: white (RAL 9016), white (RAL 9003), grey (RAL 7047), brown (RAL 8014), beige (RAL 1001), graphite (RAL 7024), black (RAL 9005). Other RAL colours are available at an extra charge - upon consultation with the Sales Department (except the metallic and pearl ones)

single leaf (slab) door		double leaf (slab) door	
"60"÷"90"	"100"÷"110"	"120"÷"150"	"160"÷"200"

ZO, range in mm 95-365

EXTRA CHARGES

additional ZOZ adjustment system for the rebated adjustable frame (wall width range increase 635 mm)

door frame lower by 50 mm or 100 mm

door frame higher by 50 mm

door frame higher by 100 mm

door frame higher by 150 mm

door frame higher by 200 mm

reinforcement for the surface mounted door closer

compatible with the electric door strike

door frames in metallic colours (p. 11)

electric strike in NC version JiS typ 1710-12 AC (including a catch plate)*

electric strike in NC version BIRA HARTE XS narrow XS12U 12V AC/DC (including a catch plate)*

electric strike in NC version with switch BIRA HARTE XS narrow XS12UW 12V AC/DC (including a catch plate)*

electric strike in NO version BIRA HARTE XS narrow XS12R 12V DC (including a catch plate)*

hinge M for the metal door frame (width "60"- "80")

replacement hinge with the T type hinge

* for leaves equipped with the ECO Schulte GBS 12 - extra charge

Door frame made of the highest quality 1.5 mm thick steel plate.

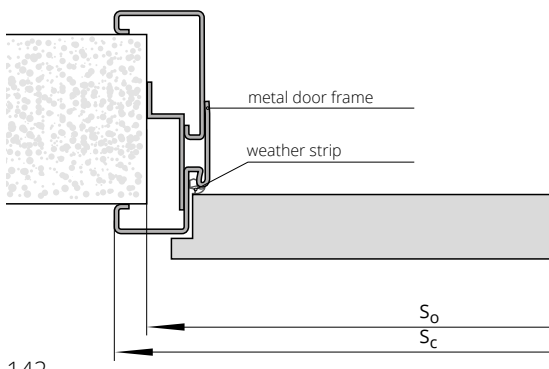

WIDTH

single leaf (slab) door					double leaf (slab) door				
type	S ₀	S _c	H ₀	H _c	type	S ₀	S _c	H ₀	H _c
"60"	689	717	2065	2078	"120"	1322	1350	2065	2078
"70"	789	817			"130"	1422	1450		
"80"	889	917			"140"	1522	1550		
"90"	989	1017			"150"	1622	1650		
"90"plus	999	1027			"160"	1722	1750		
"100"	1089	1117			"170"	1822	1850		
"110"	1189	1217			"180"	1922	1950		
					"190"	2022	2050		
					"200"	2122	2150		

S₀ - installation hole width
S_c - total door frame width

H₀ - installation hole height
H_c - total door frame height

DUO SYSTEM FIXED door frame



HIGH TOP			VENEERED		
UNI MAT PLUS	PAINTED* white	PAINTED* grey, beige	GROUP A	GROUP B	GROUP C, D
LAMISTONE CPL					
SILKSTONE					
for the laminated type					

single leaf (slab) type

double leaf (slab) type

EXTRA CHARGES

door frame lower by 55 mm or 100 mm

door frame higher by 50 mm or 100 mm

door frame higher by 150 mm or 200 mm

electric action door strike BIRA HARTE XS narrow with slip (reverse) XS12R-C 12V DC (including SPEC-525 catch plate and a cut for the electric strike)**

electric action door strike BIRA HARTE XS narrow with slip (averse) XS12U-C 12V AC/DC (including SPEC-525 catch plate and a cut for the electric strike)**

electric action door strike BIRA HARTE XS narrow with slip (averse with switch) XS12UW-C 12V AC/DC (including SPEC-525 catch plate and a cut for the electric strike)**

*environment-friendly acrylic paints, RAL and NCS colours (except metallic ones) – available at an extra charge according to the colour groups (p. 10)

** for leaves equipped with the ECO Schulte GBS 12 - extra charge, the installation hole width increased by 25 mm

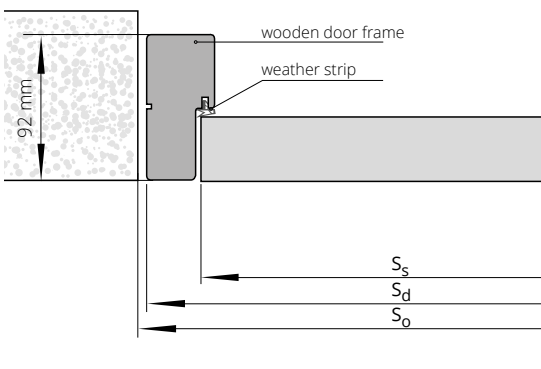

WIDTH

single leaf (slab) door			double leaf (slab) door		
type	S _o	S _d	type	S _o	S _d
"60"	713	693	"60"+"60"	1328	1308
"70"	813	793	"60"+"70"	1428	1408
"80"	913	893	"60"+"80", "70"+"70"	1528	1508
"90"	1013	993	"60"+"90", "70"+"80"	1628	1608
"90"plus	1038	1018	"70"+"90", "80"+"80"	1728	1708
			"80"+"90"	1828	1808
			"90"+"90"	1928	1908

HEIGHT

	H _o	H _d	H _s
	2093	2083	2040

S_s - door leaf (slab) width
S_d - door frame external width
S_o - installation hole width

H_s - door leaf (slab) height
H_d - door frame external height
H_o - installation hole height

DIN DUO SYSTEM ADJUSTABLE door frame

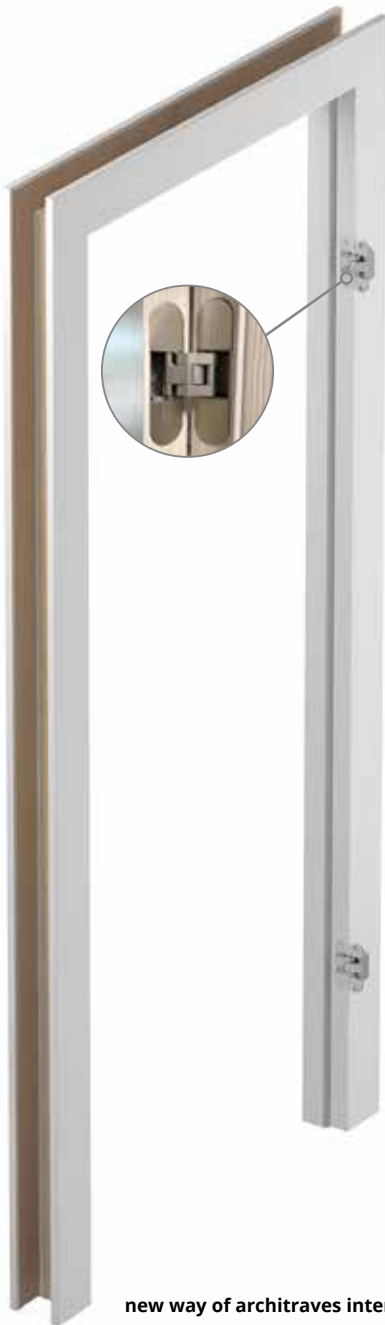

new way of architraves interconnected - p. 12



single leaf (slab) door	HIGH TOP	PAINTED* white
	LAMISTONE CPL	
	SILKSTONE	
	UNI MAT PLUS	
ECO TOP	for the laminated type	
ZD, range in mm 75-305		

single leaf (slab) door	PAINTED* grey, beige	VENEERED			BLACK black, sage
		GROUP A	GROUP B	GROUP C, D	
ZD, range in mm 75-305					

EXTRA CHARGES

double leaf (slab) type	
door frame lower by 55 mm or 100 mm	
door frame higher by 50 mm or 100 mm	
door frame higher by 150 mm or 200 mm	
"100"	
"110"	
reinforcement for the arm/guide rail door closer***	
architraves interconnected at the 90° angle (applies to B 90° and C 90° architraves version)	
electric action door strike BIRA HARTE XS narrow with slip (reverse) XS12R-C 12V DC (including SPEC-525 catch plate and a cut for the electric strike)**	
electric action door strike BIRA HARTE XS narrow with slip (averse) XS12U-C 12V AC/DC (including SPEC-525 catch plate and a cut for the electric strike)**	
electric action door strike BIRA HARTE XS narrow with slip (averse with switch) XS12UW-C 12V AC/DC (including SPEC-525 catch plate and a cut for the electric strike)**	
crown	p. 157

The installation door width must be enlarged by 15 mm for the DUO non-rebated system door leaves equipped with the HOBES lock.
Door frames with ranges wider than the maximum ones provided in the table above are available (upon consultation with the Sales Department).

*environment-friendly acrylic paints, RAL and NCS colours (except metallic ones)

- available at an extra charge according to the colour groups (p. 10)

** for leaves equipped with the ECO Schulte GBS 12 - extra charge, the installation hole width increased by 25 mm

***NOTE! The recommended dimension of the installation hole height increased by 16 mm.

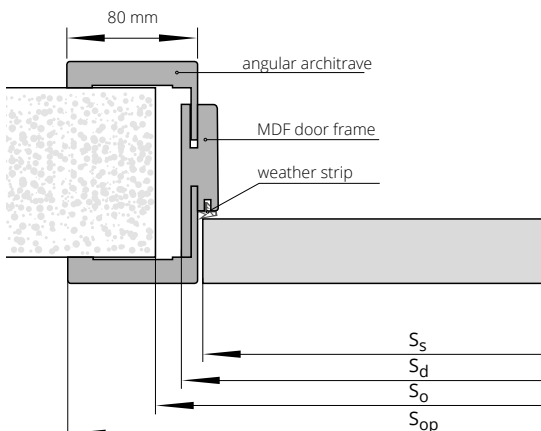

WIDTH										
single leaf (slab) door						double leaf (slab) door				
type	So	Sd	Ss	Sop	SopF	type	So	Sd	Sop	SopF
"60"	690	652	625	792	794	"60"+"60"	1305	1267	1407	1409
"70"	790	752	725	892	894	"60"+"70"	1405	1367	1507	1509
"80"	890	852	825	992	994	"60"+"80","70"+"70"	1505	1467	1607	1609
"90"	990	952	925	1092	1094	"60"+"90","70"+"80"	1605	1567	1707	1709
"90 plus"	1015	977	950	1117	1119	"70"+"90","80"+"80"	1705	1667	1807	1809
						"80"+"90"	1805	1767	1907	1909
						"90"+"90"	1905	1867	2007	2009
HEIGHT						H _o	H _d	H _s	H _{op}	
						2075	2063	2040	2133	

Ss - door leaf (slab) width
Sd - door frame external width
So - installation hole width
Sop - architrave external width
SopF - dimension for veneered door frame

Hs - door leaf (slab) height
Hd - door frame external height
Ho - installation hole height
Hop - architrave external height

AQUA DIN DUO ADJUSTABLE door frame

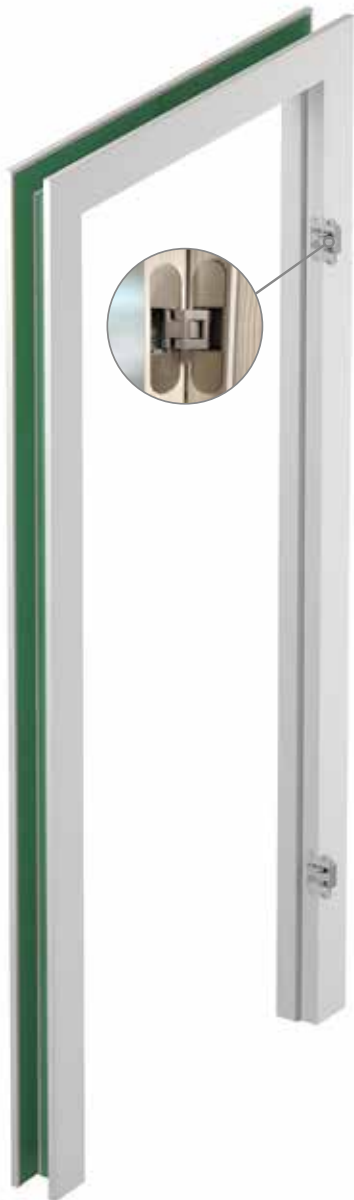

single
leaf (slab) door

ECO TOP	UNI MAT PLUS	HIGH TOP
		LAMISTONE CPL
		SILKSTONE
for the laminated type		

ZD, range in mm 75-305

single leaf (slab) door	PAINTED white	PAINTED beige, grey	VENEERED			BLACK black, sage
			GROUP A	GROUP B	GROUP C	

ZD, range in mm 75-305

architraves interconnected at the 45° angle

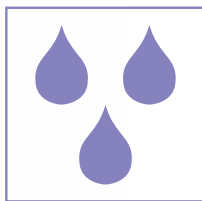

door frame made of high quality
MDF board characterized by high
resistance to moisture

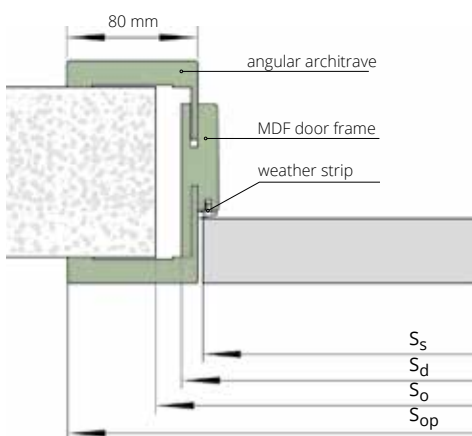

WIDTH

single leaf (slab) door						double leaf (slab) door				
type	So	Sd	Ss	Sop	SopF	type	So	Sd	Sop	SopF
"60"	690	652	625	792	794	"60"+"60"	1305	1267	1407	1409
"70"	790	752	725	892	894	"60"+"70"	1405	1367	1507	1509
"80"	890	852	825	992	994	"60"+"70", "70"+"70"	1505	1467	1607	1609
"90"	990	952	925	1092	1094	"60"+"90", "70"+"80"	1605	1567	1707	1709
"90 plus"	1015	977	950	1117	1119	"70"+"90", "80"+"80"	1705	1667	1807	1809
						"80"+"90"	1805	1767	1907	1909
						"90"+"90"	1905	1867	2007	2009

HEIGHT

	Ho	Hd	Hs	Hop
	2075	2063	2040	2133

Ss - door leaf (slab) width
Sd - door frame external width
So - installation hole width
Sop - architrave external width
SopF - veneered door frame width

Hs - door leaf (slab) height
Hd - door frame external height
Ho - installation hole height
Hop - architrave external height

DUO SYSTEM ADJUSTABLE door frame

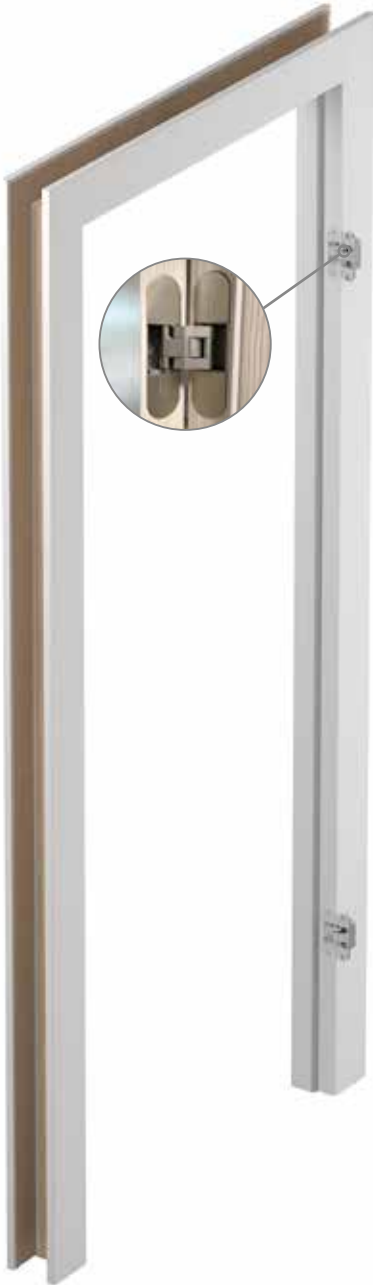

single leaf (slab)
door

HIGH TOP	VENEERED		
UNI MAT PLUS			
LAMISTONE CPL			
SILKSTONE	GROUP A	GROUP B	GROUP C, D
for the laminated type			

DI, range in mm 76-388

EXTRA CHARGES

double leaf (slab) type
door frame lower by 55 mm or 100 mm
door frame higher by 50 mm or 100 mm
door frame higher by 150 mm or 200 mm
"100"
"110"
architraves interconnected at the 90° angle
electric action door strike BIRA HARTE XS narrow with slip (reverse) XS12R-C 12V DC (including SPEC-525 catch plate and a cut for the electric strike)*
electric action door strike BIRA HARTE XS narrow with slip (averse) XS12U-C 12V AC/DC (including SPEC-525 catch plate and a cut for the electric strike)*
electric action door strike BIRA HARTE XS narrow with slip (averse with switch) XS12UW-C 12V AC/DC (including SPEC-525 catch plate and a cut for the electric strike)*
crown
p. 157

* for leaves equipped with the ECO Schulte GBS 12 - extra charge
Door frames with ranges wider than the maximum ones provided in the table above are available (upon consultation with the Sales Department).

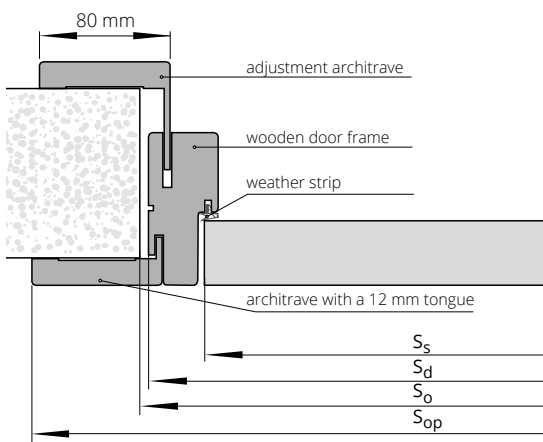

WIDTH

single leaf (slab) door					double leaf (slab) door			
type	S _o	S _d	S _s	S _{op}	type	S _o	S _d	S _{op}
"60"	713	693	625	836	"60"+"60"	1328	1308	1451
"70"	813	793	725	936	"60"+"70"	1428	1408	1551
"80"	913	893	825	1036	"60"+"80","70"+"70"	1528	1508	1651
"90"	1013	993	925	1136	"60"+"90","70"+"80"	1628	1608	1751
"90 plus"	1038	1018	950	1161	"70"+"90","80"+"80"	1728	1708	1851
					"80"+"90"	1828	1808	1951
					"90"+"90"	1928	1908	2051

HEIGHT

	H _o	H _d	H _s	H _{op}
	2093	2083	2040	2154

S_s - door leaf (slab) width
S_d - door frame external width
S_o - installation hole width
S_{op} - architrave external width

H_s - door leaf (slab) height
H_d - door frame external height
H_o - installation hole height
H_{op} - architrave external height

VERTIGO ADJUSTABLE door frame

ARCHITRAVE AND CROSS RAIL CONNECTION SYSTEM



Wood grain of door frame - vertical (LAMISTONE: 241, 242; SILKSTONE: 293, 294, 295, 296)
wood grain of panel - horizontal (SILKSTONE: 254, 255, 299)

Horizontal wood grain (SILKSTONE: 254, 255, 299)

Vertical wood grain (LAMISTONE: 241, 242; SILKSTONE: 293, 294, 295, 296)

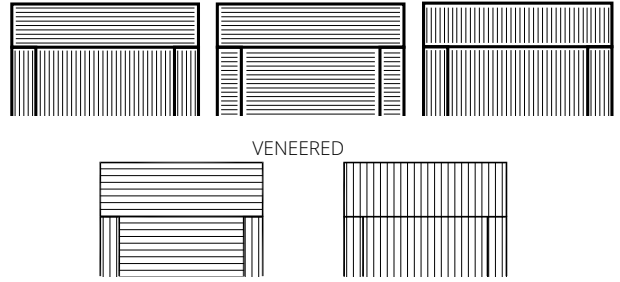

single leaf (slab) door		complete set (panel / adjustment architrave) in mm
symbol	range in mm	
ZV1	75-80	75/12
ZV2	80-85	80/12
ZV3	85-95	85/16
ZV4	95-120	95/32
ZV5	120-140	120/32
ZV6	140-160	140/32
ZV7	160-180	160/32
ZV8	180-200	180/32
ZV9	200-220	200/32
ZV10	220-240	220/32
ZV11	240-260	240/32
ZV12	260-280	260/32
ZV13	280-305	280/32

UNI MAT PLUS	PAINTED*		BLACK	VENEERED		
LAMISTONE CPL	white	grey, beige	black, sage	GROUP A	GROUP B	GROUP C, D
SILKSTONE						

EXTRA CHARGES

Door frames with ranges wider than the maximum ones provided in the table above are available (upon consultation with the Sales Department).
*environment-friendly acrylic paints, RAL and NCS colours (except metallic ones) - available at an extra charge according to the colour groups (p. 10)
**NOTE! The recommended dimension of the installation hole height increased by 16 mm.
*** for leaves equipped with the ECO Schulte GBS 12 - extra charge, the installation hole width increased by 15 mm

door frame lower by 55 mm or 100 mm
door frame higher by 50 mm or 100 mm
reinforcement for surface mounted door closer**
electric action door strike BIRA HARTE XS narrow with slip (reverse) XS12R-C 12V DC (including SPEC-525 catch plate and a cut for the electric strike)***
electric action door strike BIRA HARTE XS narrow with slip (averse) XS12U-C 12V AC/DC (including SPEC-525 catch plate and a cut for the electric strike)***
electric action door strike BIRA HARTE XS narrow with slip (averse with switch) XS12UW-C 12V AC/DC (including SPEC-525 catch plate and a cut for the electric strike)***

COMPLETE SET PRICE = VERTIGO DOOR FRAME PRICE + VERTIGO PANEL PRICE

VERTIGO PANEL 1 set (2 pcs)

VERTIGO TOP PANELS HAVE R3 RADIUS ON VERTICAL EDGES IN LAMISTONE, SILKSTONE, UNI MAT PLUS AND PAINTED VERSIONS. IT DOES NOT APPLY TO THE VENEERED VERSION.

UNI MAT PLUS	PAINTED*		BLACK	VENEERED			
LAMISTONE CPL	white	grey, beige	black, sage	GROUP A	GROUP A herringbone	GROUP B	GROUP C, D
SILKSTONE							

range in mm 100-1000

WIDTH						
single leaf (slab) door						
type	So	Sd	Ss	Sop	SopL	SopF
"60"	690	652	625	793	793	795
"70"	790	752	725	893	893	895
"80"	890	852	825	993	993	995
"90"	990	952	925	1093	1093	1095
"90 plus"	1015	977	950	1117	1118	1120
HEIGHT						
	Ho	Hd	Hop			
	2082	2070	2353			

Ss - door leaf (slab) width
Sd - door frame external width
So - installation hole width
Sop - architrave external width
SopL - door frame dimension on the adjustment side for laminated and painted door frame
SopF - door frame dimension on the adjustment side for veneered door frame
Hs - door leaf (slab) height
Hd - door frame external height
Ho - installation hole height
Hop - panel external height

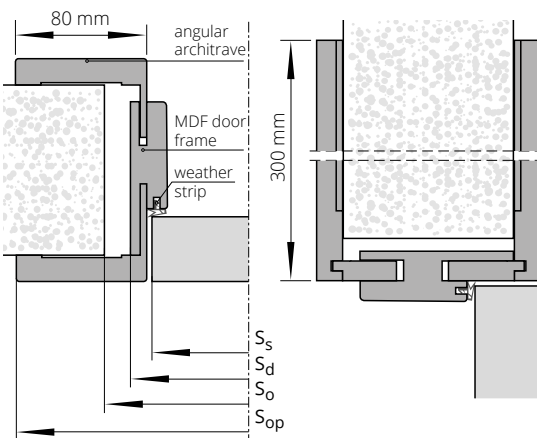

POL-SKONE SYSTEM METAL DUO FIXED door frame



NOTE! The DUO metal frame price includes the DUO concealed hinges.

COLOURS

Powder-coated door frame.
Standard colours: white (RAL 9016), white (RAL 9003), grey (RAL 7047), brown (RAL 8014), beige (RAL 1001), graphite (RAL 7024), black (RAL 9005). Other RAL colours are available at an extra charge - upon consultation with the Sales Department (except the metallic and pearl ones)



	single leaf (slab) door			double leaf (slab) door		
	F93, range in mm 101					
	"60"±"80"	"90"	"100"±"110"	"60"±"60", "60"±"70", "60"±"80", "70"±"70", "70"±"80"	"90"±"60"	"160"±"200"
number of concealed hinges	2 pcs.	3 pcs.	3 pcs.	4 pcs.	6 pcs.	6 pcs.

EXTRA CHARGES

- door frame lower by 55 mm or 100 mm
- door frame higher by 50 mm
- door frame higher by 100 mm
- door frame higher by 150 mm
- door frame higher by 200 mm
- reinforcement for the surface mounted door closer
- compatible with the electric door strike
- door frames in metallic colours (p. 11)
- electric action door strike BIRA HARTE XS narrow with slip (reverse) XS12R-C 12V DC (including SPEC-576 catch plate and a cut for the electric strike)*
- electric action door strike BIRA HARTE XS narrow with slip (averse) XS12U-C 12V AC/DC (including SPEC-576 catch plate and a cut for the electric strike)*
- electric action door strike BIRA HARTE XS narrow with slip (averse with switch) XS12UW-C 12V (including SPEC-576 catch plate and a cut for the electric strike)*

* for leaves equipped with the ECO Schulte GBS 12 - extra charge

The installation hole must be enlarged for door frames equipped with an electric strike by additional 5 mm.

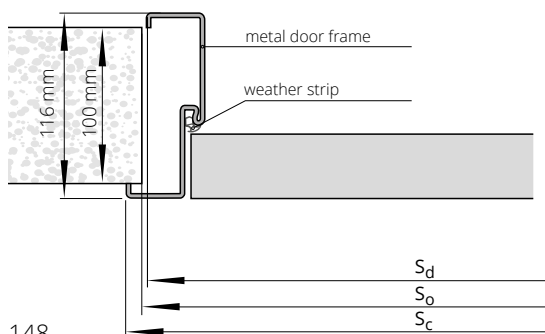

WIDTH							
single leaf (slab) door				double leaf (slab) door			
type	S _o	S _d	S _c	type	S _o	S _d	S _c
"60"	685	675	701	"120"	1300	1290	1316
"70"	785	775	801	"130"	1400	1390	1416
"80"	885	875	901	"140"	1500	1490	1516
"90"	985	975	1001	"150"	1600	1590	1616
"90"plus	1010	1000	1026	"160"	1700	1690	1716
"100"	1085	1075	1101	"170"	1800	1790	1816
"110"	1185	1175	1201	"180"	1900	1890	1916
				"190"	2000	1990	2016
				"200"	2100	2090	2116
HEIGHT				H _o	H _c	H _d	
				2080	2088	2075	

S_d - door frame external width
S_o - installation hole width
S_c - total door frame width

H_d - door frame external height
H_o - installation hole height
H_c - total door frame height

POL-SKONE SYSTEM METAL DUO ADJUSTABLE door frame



NOTE! The DUO metal frame price includes the DUO concealed hinges.

COLOURS

Powder-coated door frame.
Standard colours: white (RAL 9016), white (RAL 9003), grey (RAL 7047), brown (RAL 8014), beige (RAL 1001), graphite (RAL 7024), black (RAL 9005). Other RAL colours are available at an extra charge - upon consultation with the Sales Department (except the metallic and pearl ones)

	single leaf (slab) door			double leaf (slab) door		
	F7, range in mm 110-380					
	"60"÷"80"	"90"	"100"÷"110"	"60"÷"60", "60"÷"70", "60"÷"80", "70"÷"70", "70"÷"80"	"90"÷"60"	"160"÷"200"
number of concealed hinges	2 pcs.	3 pcs.	3 pcs.	4 pcs.	6 pcs.	6 pcs.

EXTRA CHARGES

additional ZOX adjustment system for the rebated adjustable frame (wall width range increase 650 mm)

door frame lower by 55 mm or 100 mm

door frame higher by 50 mm

door frame higher by 100 mm

door frame higher by 150 mm

door frame higher by 200 mm

reinforcement for the surface mounted door closer

compatible with the electric door strike

door frames in metallic colours (p. 11)

electric action door strike BIRA HARTE XS narrow with slip (reverse) XS12R-C 12V DC (including SPEC-576 catch plate and a cut for the electric strike)*

electric action door strike BIRA HARTE XS narrow with slip (averse) XS12U-C 12V AC/DC (including SPEC-576 catch plate and a cut for the electric strike)*

electric action door strike BIRA HARTE XS narrow with slip (averse with switch) XS12UW-C 12V (including SPEC-576 catch plate and a cut for the electric strike)*

* for leaves equipped with the ECO Schulte GBS 12 - extra charge

WIDTH

single leaf (slab) door			double leaf (slab) door		
type	S _c	S _o	type	S _c	S _o
"60"	721	693	"120"	1336	1308
"70"	821	793	"130"	1436	1408
"80"	921	893	"140"	1536	1508
"90"	1021	993	"150"	1636	1608
"90"plus	1046	1018	"160"	1736	1708
"100"	1121	1093	"170"	1836	1808
"110"	1221	1193	"180"	1936	1908
			"190"	2036	2008
			"200"	2136	2108

HEIGHT

H _o	H _c
2085	2098

S_o - installation hole width
S_c - total door frame width

H_o - installation hole height
H_c - total door frame height

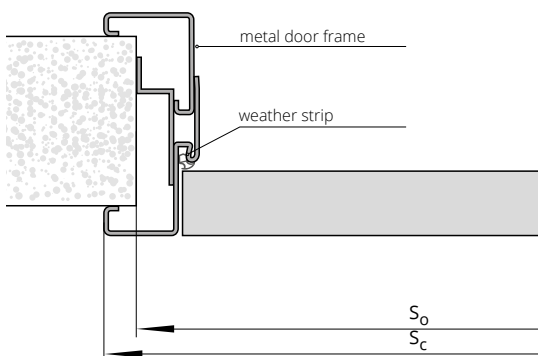

REVES SYSTEM ADJUSTABLE door frame



single leaf (slab) door	ECO TOP	for the laminated type	PAINTED* white	PAINTED* grey, beige	BLACK black, sage	VENEERED		
		UNI MAT PLUS				GROUP A	GROUP B	GROUP C, D
		HIGH TOP						
		LAMISTONE CPL						
		SILKSTONE						

ZW, range in mm 75-295

*RAL and NCS colours - available at an extra charge according to the colour specification table.

EXTRA CHARGES

door frame higher by 100 mm

change of colour of the chrome matt hinge to black (RAL 9005) or white (RAL 9016)

type	Sd	SopA	SopB	Ss	So
"60"	676	766	816	625	705
"70"	776	866	916	725	805
"80"	876	966	1016	825	905
"90"	976	1066	1116	925	1005
"90 plus"	1001	1091	1141	950	1030
"100"	1076	1166	1216	1025	1105

type	Hd	HopA	HopB	Hs	Ho
standard	2088	2133	2158	2053	2105
+50	2138	2183	2208	2103	2155
+100	2188	2233	2258	2153	2205
+200	2288	2333	2358	2253	2305
-55	2033	2078	2103	1998	2050
-100	1988	2033	2058	1953	2005

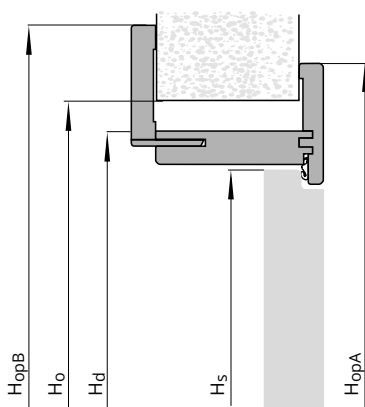
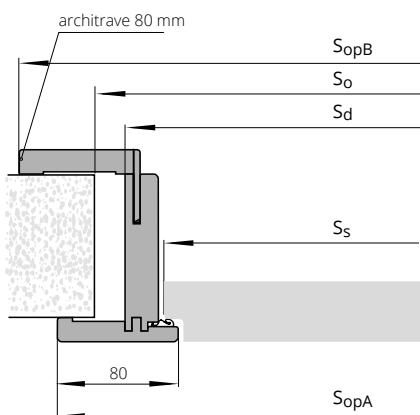

Ss - door leaf (slab) width
Sd - door frame external width
So - installation hole width
SopA - architrave external width on the hinge side
SopB - architrave external width on the adjustment side

Hs - door leaf (slab) height
Hd - door frame external height
Ho - installation hole height
HopA - architrave external height on the hinge side
HopB - architrave external height on the adjustment side

ADJUSTMENT SYSTEM

MADE OF MDF

FOR FIXED METAL door frame



Dedicated to:
 FD93 non-rebated metal door frame
 FD12 rebated metal door frame
 Fixed metal door frame for RC3, RC3 INVEST door
 Fixed metal door frame for CERBER PLUS, CERBER PLUS RC2 door

COLOURS

FD12, FD93, RC3 fixed metal door frame
 Cerber Plus: powder painted in colours from RAL palette
 Adjustment system made of MDF: ECO TOP, HIGH TOP, LAMISTONE, SILKSTONE, VENEERED GROUP A, B, C.

single leaf (slab) door	ECO TOP	for the laminated type	VENEERED		
		HIGH TOP	GROUP A	GROUP B	GROUP C, D
		LAMISTONE CPL			
		SILKSTONE			
MA, MB, range in mm 175-415					

EXTRA CHARGES

double leaf (slab) door

(*) the adjustment range includes the thickness of the FD12, CERBER PLUS, RC3 and FD93 door frames
 MA: adjustments for FD12, CERBER PLUS, RC3
 MB: adjustments for FD93

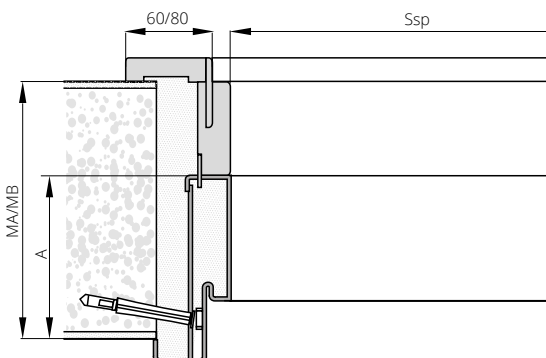

WIDTH (Ssp)

type	single leaf (slab) door			
	FD12	CERBER PLUS	RC3 RC3 INVEST	FD93
"60"	601	-	-	605
"70"	701	-	701	705
"80"	801	801	801	805
"90"	901	901	901	905
"90 plus"	-	911	921	-
"100"	1001	1001	1001	1005
"110"	1101	-	-	1105
"120"	1201	-	-	1205
HEIGHT (Hsp)	2020	2020	2020	2040
A	109	109	112	109

Ssp - panel width within the clear opening

Hsp - panel height within the clear opening

TUNNELS / WALL ENCASEMENTS

VERTIGO TUNNEL DOOR FRAME

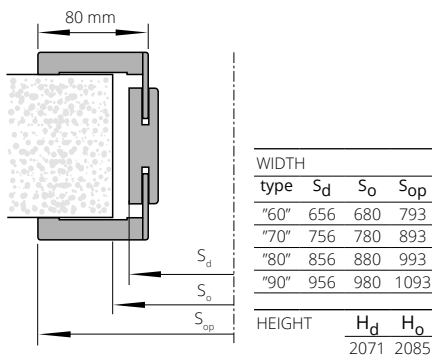

PAINTED* white	PAINTED* grey, beige	BLACK black, sage	UNI MAT PLUS	VENEERED		
			LAMISTONE	GROUP A	GROUP B	GROUP C, D
		SILKSTONE				
Adjustment range	Range in mm	Complete set of elements				
VT 1	76-96	Vertical elements				
VT 2	96-116	Panel 76 mm, architrave with tongue 32 mm				
VT 3	116-142	Panel 76 mm, architrave with tongue 52 mm				
VT 4	142-182	Panel 142 mm, architrave with tongue 32 mm				
VT 5	182-208	Panel 142 mm, architrave with tongue 52 mm				
VT 6	208-248	Panel 208 mm, architrave with tongue 32 mm				
VT 7	248-274	Panel 208 mm, architrave with tongue 52 mm				
VT 8	274-314	Panel 274 mm, architrave with tongue 32 mm				
VT 9	314-354	Panel 274 mm, architrave with tongue 52 mm				

Net price - main part of the tunnel encasement

*applicable to 80 mm wide architraves

WALL ENCASEMENT FINISH TUNNEL:
ZN (encasement for the on-wall sliding system)
and ZT (wall encasement without door)

ECO TOP	HIGH TOP	PAINTED* white	PAINTED* grey, beige	VENEERED		
	LAMISTONE CPL			GROUP A	GROUP B	GROUP C, D
	SILKSTONE					
	UNI MAT PLUS					
for the laminated type						

Adjustment range

Complete set of elements

On-wall system	Tunnel system	Range in mm	Standard dimensions
ZN 1	ZT 1	76-116	Panel 76 mm, architrave with tongue 32 mm
ZN 2	ZT 2	116-142	Panel 76 mm, architrave with tongue 52 mm
ZN 3	ZT 3	142-182	Panel 142 mm, architrave with tongue 32 mm
ZN 4	ZT 4	182-208	Panel 142 mm, architrave with tongue 52 mm
ZN 5	ZT 5	208-248	Panel 208 mm, architrave with tongue 32 mm
ZN 6	ZT 6	248-274	Panel 208 mm, architrave with tongue 52 mm
ZN 7	ZT 7	274-314	Panel 274 mm, architrave with tongue 32 mm
ZN 8	ZT 8	314-354	Panel 274 mm, architrave with tongue 52 mm

EXTRA CHARGES

non-standard height of tunnels (up to 2300 mm)

double leaf (slab) tunnels dimension "100"+"100"

double leaf (slab) tunnels dimension "110"+"110"

DUO system tunnel door frame

"100"; "110"

architraves interconnected at the 90° angle (applicable to 80 mm wide architraves)

environment-friendly acrylic paints, RAL and NCS colours (except metallic ones) - available at an extra charge according to the colour groups (p. 10)

*applicable to 80 mm wide architraves

ZN, ZN DUO SYSTEM TUNNEL DOOR FRAME (not applicable to DIN DUO)
(wall encasement for the sliding on-wall system)
ZT SYSTEM DIN TUNNEL DOOR FRAME
(wall encasement for DIN door frames without door)

WIDTH									
single leaf (slab) door					double leaf (slab) door				
type	S _d	S _o	S _{op}	S _{op} *	type	S _d	S _o	S _{op} *	
"60"	649	670	746	786	"60"+"60"	1282	1305	1379	1419
"70"	749	770	846	886	"70"+"70"	1482	1505	1579	1619
"80"	849	870	946	986	"80"+"80"	1682	1705	1779	1819
"90"	949	970	1046	1086	"90"+"90"	1882	1905	1979	2019
"100"	1049	1070	1146	1186	"100"+"100"	2082	2105	2179	2219

HEIGHT			
H _d	H _o	H _{op}	H _{op} *
2044	2055	2093	2113

* DUO SYSTEM (not applicable to DIN DUO)

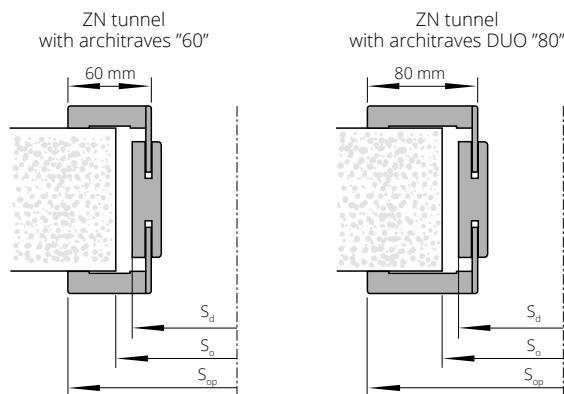

60 mm wide architraves are not available in the painted version

S_d - door frame external width
S_o - installation hole width
S_{op} - architrave external width

H_d - door frame external height
H_o - installation hole height
H_{op} - architrave external height

ZT POL-SKONE SYSTEM TUNNEL DOOR FRAME (not applicable to ZT DIN)
(wall encasement without door)

WIDTH							
single leaf (slab) door				double leaf (slab) door			
type	S _d	S _o	S _{op}	type	S _d	S _o	S _{op}
"60"	700	720	797	"60"+"60"	1334	1360	1431
"70"	800	820	897	"60"+"70"	1434	1460	1531
"80"	900	920	997	"60"+"80", "70"+"70"	1534	1560	1631
"90"	1000	1020	1097	"60"+"90", "70"+"80"	1634	1660	1731
"100"	1100	1120	1197	"70"+"90", "80"+"80"	1734	1760	1831
				"80"+"90"	1834	1860	1931
				"90"+"90"	1934	1960	2031
				"100"+"100"	2134	2160	2231
HEIGHT				H _d	H _o	H _{op}	
				2069	2080	2118	

Available only with the colours of natural veneers

ZT tunnel with the "60" architraves

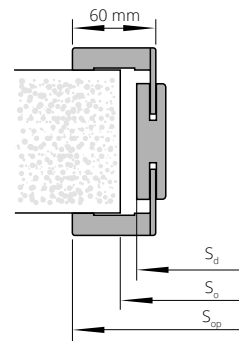

60 mm wide architraves are not available in the painted version

ZT DIN DUO SYSTEM TUNNEL DOOR FRAME
(wall encasement without door)

WIDTH							
single leaf (slab) door				double leaf (slab) door			
type	S _o	S _d	S _{op}	type	S _o	S _d	S _{op}
"60"	675	655	792	"60"+"60"	1290	1270	1407
"70"	775	755	892	"60"+"70"	1390	1370	1507
"80"	875	855	992	"60"+"80", "70"+"70"	1490	1470	1607
"90"	975	955	1092	"60"+"90", "70"+"80"	1590	1570	1707
				"70"+"90", "80"+"80"	1690	1670	1807
				"80"+"90"	1790	1770	1907
				"90"+"90"	1890	1870	2007
HEIGHT				H _o	H _d	H _{op}	
				2075	2065	2133	

ZT tunnel with the "80" architraves

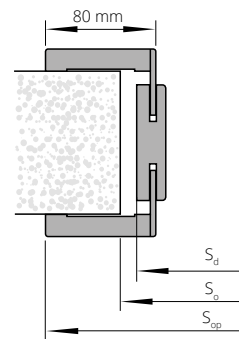

ZT tunnel for the DUO SYSTEM door
(wall encasement without door)

WIDTH							
single leaf (slab) door				double leaf (slab) door			
type	S _d	S _o	S _{op}	type	S _d	S _o	S _{op}
"60"	699	720	836	"60"+"60"	1326	1350	1463
"70"	799	820	936	"60"+"70"	1426	1450	1563
"80"	899	920	1036	"70"+"70"	1526	1550	1663
"90"	999	1020	1136	"70"+"80"	1626	1650	1763
				"80"+"80"	1726	1750	1863
				"80"+"90"	1826	1850	1963
				"90"+"90"	1926	1950	2063
HEIGHT				H _d	H _o	H _{op}	
				2085	2095	2154	

ZT tunnel with the "80" architraves

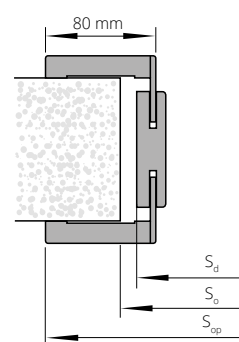

S_d - door frame external width
S_o - installation hole width
S_{op} - architrave external width

H_d - door frame external height
H_o - installation hole height
H_{op} - architrave external height



TOPLIGHTS

FOR DIN/DIN DUO DOOR FRAME

REBATED SYSTEM

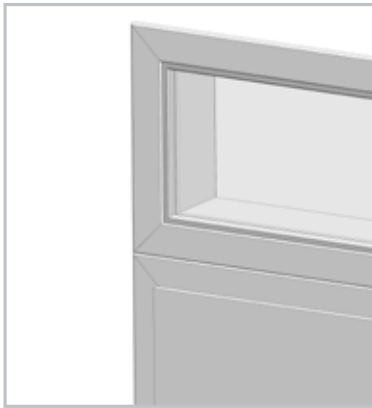

TOPLIGHTS on the DIN door frame profile

(price per 1 meter of the toplight along its external perimeter)

<div style="display: flex; justify-content: space-around;"> <div style="background-color: #90EE90; padding: 5px;">PAINTED* white</div> <div style="background-color: #90EE90; padding: 5px;">PAINTED* grey, beige</div> <div style="background-color: #FF0000; padding: 5px;">ECO TOP</div> </div>	for the laminated type	VENEERED	
		HIGH TOP	<div style="display: flex; justify-content: space-between;"> GROUP A GROUP B GROUP C, D </div>
		LAMISTONE CPL	
		SILKSTONE	
		UNI MAT PLUS	

NP, range in mm 75-300

toplight price = 1m price x 2(A+B) + glass 1 sq. m. price x A x B
optional use of 80 mm architraves

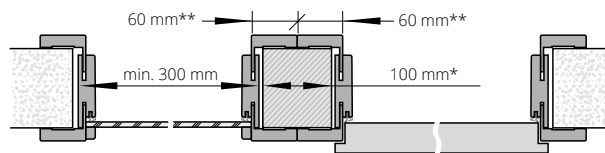
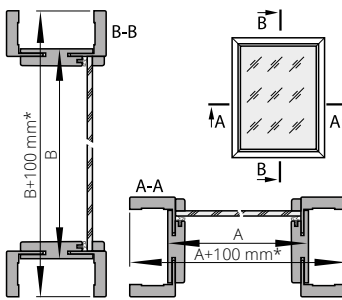

Maximum dimension of toplights and sidelights is:
 - toplights SxH = 2190x700 mm
 - sidelights SxH = 1000x2093 mm
 *In case when 80 mm - 140 mm architraves are used
 **In case when 80 mm - 80 mm architraves are used

NON-REBATED SYSTEM



TOPLIGHTS on the DIN DUO door frame profile

(price per 1 meter of the toplight along its external perimeter)

<div style="display: flex; justify-content: space-around;"> <div style="background-color: #90EE90; padding: 5px;">PAINTED* white</div> <div style="background-color: #90EE90; padding: 5px;">PAINTED* grey, beige</div> <div style="background-color: #FF0000; padding: 5px;">ECO TOP</div> </div>	for the laminated type	VENEERED	
		HIGH TOP	<div style="display: flex; justify-content: space-between;"> GROUP A GROUP B GROUP C, D </div>
		LAMISTONE CPL	
		SILKSTONE	
		UNI MAT PLUS	

ND, range in mm 75-300

toplight price = 1m price x 2(A+B) + glass 1 sq. m. price x A x B

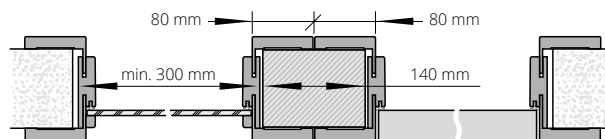
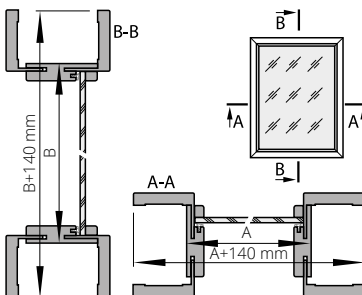

The maximum dimension of toplights and sidelights is:
 - toplight SxH = 2207x700 mm
 - sidelight SxH = 1000x2133 mm

USE THE TOPLIGHT WITH THE FOLLOWING GLASS PANE TYPES:

- A. Security glass pane, white matt 3.3.1, thickness: 6.4 mm
- B. Security glass pane, transparent 3.3.1, thickness: 6.4 mm
- C. White matt tempered glass pane, thickness: 6 mm
- D. Tempered transparent glass pane, thickness: 6 mm

The architraves of the DIN/DIN DUO toplights cannot be provided at an angle of 90°.

Recommended way of connecting toplights along the DIN/DIN DUO door frame by means of installation blocks

*environment-friendly acrylic paints, RAL and NCS colours (except metallic ones) – available at an extra charge according to the colour groups (p. 10)



TOPLIGHTS FOR THE FIXED DOOR FRAME

TOPLIGHTS on the door frame profile:
POL-SKONE fixed (rebated system)
DUO fixed (non-rebated system)
 (price per 1 meter of the toplight/sidelight along its external perimeter)

PAINTED* white	for the laminated type	VENEERED		
	UNI MAT PLUS	GROUP A	GROUP B	GROUP C, D
	HIGH TOP			
	LAMISTONE CPL			
SILKSTONE				

fixed 92 mm

topligh price = 1m price x 2(A+B) + glass 1 sq. m. price x A x B

REBATED SYSTEM

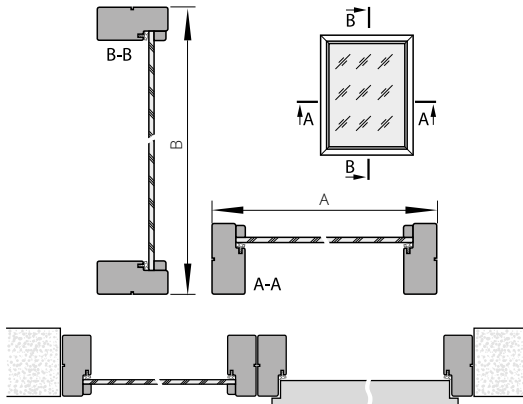

NON-REBATED SYSTEM

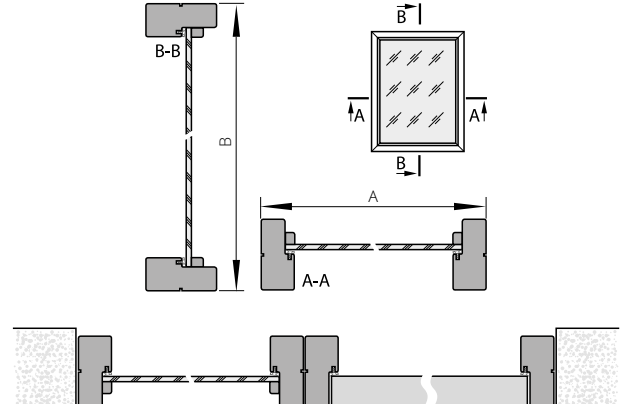

Recommended method of connecting toplights on the fixed/DUO fixed door frame profile

*environment-friendly acrylic paints, RAL and NCS colours (except metallic ones) – available at an extra charge according to the colour groups (p. 10)

SEMPRE INTERIOR DOOR SIDE PANELS

The side panels are compatible with the models SEMPRE, SEMPRE LUX (version W02, W03)

PRICE OF DOOR Leaf (slab) WITH INACTIVE Leaf (slab) = 2 x DOOR Leaf (slab) PRICE

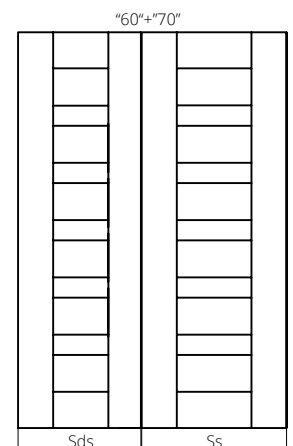
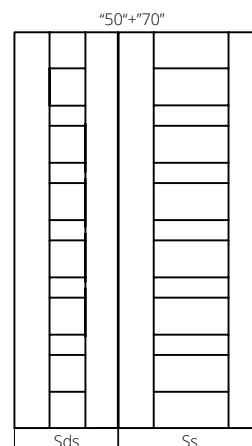
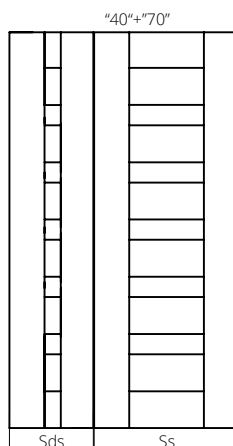

WIDTH (rebated system)		
type	Ss with a rebate	Sds
"40"+ "70"		431
"50"+ "70"	744	531
"60"+ "70"		631
"40"+ "80"		431
"50"+ "80"	844	531
"60"+ "80"		631
"40"+ "90"		431
"50"+ "90"	944	531
"60"+ "90"		631

WIDTH (non-rebated system)		
type	Ss	Sds
"40"+ "70"		412
"50"+ "70"	725	512
"60"+ "70"		612
"40"+ "80"		412
"50"+ "80"	825	512
"60"+ "80"		612
"40"+ "90"		412
"50"+ "90"	925	512
"60"+ "90"		612



STRIPS

ECO TOP	for the laminated type	PAINTED* white	VENEERED		
	UNI MAT PLUS		GROUP A	GROUP B	GROUP C, D
	HIGH TOP				
	LAMISTONE CPL				
SILKSTONE					

STRIP TYPE	symbol	LC1F	LC1F	LC1F	LC10	LC10	LC10
OVAL STRIP LC1 	for the single leaf (slab) door	X	X	X	X	X	X
	for the double leaf (slab) door	X	X	X	X	X	X
MASKING STRIP LD6 	for the single leaf (slab) door	X	X	-	X	X	X
	for the double leaf (slab) door	X	X	-	X	X	X
MASKING STRIP LD10 	for the single leaf (slab) door	X	X	X	X	X	X
	for the double leaf (slab) door	X	X	X	X	X	X

*environment-friendly acrylic paints, RAL and NCS colours (except metallic ones) – available at an extra charge according to the colour groups (p. 10)

Strips in the following colors: 244 black, 258 white, 276 Polish oak, 295 Royal merbau, 80 mm high, available from stock.

RECOMMENDED CONNECTIONS OF STRIPS

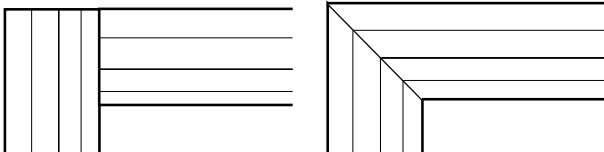

LD10

complete set for the single leaf (slab) door: 2 strips with a length of 2200 mm + 1 strip with a length of 1150 mm; complete set for double leaf (slab) door: 3 strips with a length of 2200 mm;

LC1, LD6

complete set for the single leaf (slab) door: 2 strips with a length of 2150 mm + 1 strip with a length of 1150 mm; complete set for double leaf (slab) door: 3 strips with a length of 2150 mm

BASEBOARDS

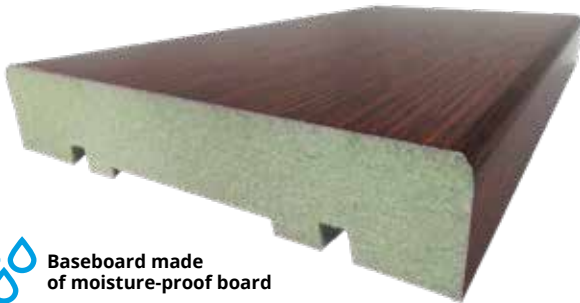

 **Baseboard made of moisture-proof board**

PAINTED* white	UNI MAT PLUS	VENEERED		
	LAMISTONE	GROUP A	GROUP B	GROUP C, D
	SILKSTONE			

Baseboards available as 2.6 m long elements.

Minimum order volume for a single colour is 5 elements (1 package).

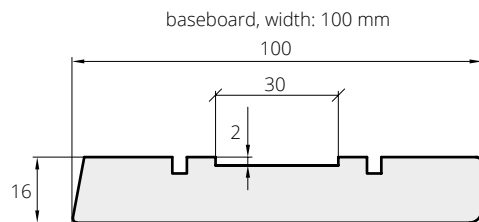
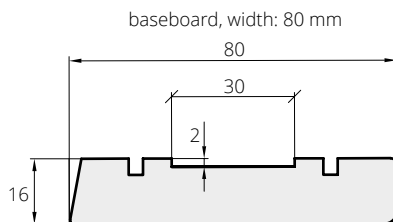

ABS EDGING



- high mechanical and moisture resistance
- product recommended by specialists
- dedicated to LOFTY, IMPULS, HAPTIC, DECO doors



PORTHOLES



size	S ₀	colour
porthole 1 (Ø 240 mm, gr. 18, 40 mm)	135 mm	stainless steel (mat) glass - lacomat
porthole 2 (Ø 320 mm, gr. 18, 40 mm)	215 mm	
porthole 3 (Ø 350 mm, gr. 18, 40 mm)	235 mm	
porthole 4 (Ø 400 mm, gr. 18, 40 mm)	280 mm	

size	S ₀	colour
porthole 2 (Ø 300 mm, gr. 35-45 mm)	225 mm	stainless steel (mat) glass - lacomat
porthole 3 (Ø 350 mm, gr. 35-45 mm)	265 mm	
porthole 4 (Ø 400 mm, gr. 35-45 mm)	295 mm	

size	S ₀	colour
porthole 2 (Ø 300 mm, gr. 35-45 mm)	225 mm	stainless steel (mat) glass - lacomat
porthole 3 (Ø 350 mm, gr. 35-45 mm)	265 mm	
porthole 4 (Ø 400 mm, gr. 35-45 mm)	295 mm	

DOOR MODELS	PORTHOLES ONLY IN FLUSH VERSIONS	NOTES
DECO, HAPTIC	BMD, BMJ, BMN	
DECO LUX	BMD, BMJ, BMN	
ETIUADA version B0 ETIUADA LUX version B0	BMD, BMJ, BMN	
IMPULS	(BMD, BMJ, BMN) ¹	1) only in the 01 version
INTERSOLID II ²	BMD ¹	1) porthole only with widths of "70", "80" and "90" 2) not applicable to versions 10, 11
INTERSOLID	BMD ¹	1) porthole only with widths of "70", "80" and "90"
MODERN, MODERN DUO	BMD ¹	1) porthole only with widths of "70", "80" and "90"
CAMBIO, CAMBIO DUO	BMD, BMJ, BMN	
INTER-AMBER	BMD, BMJ, BMN	
SIMPLE, SIMPLE DUO	BMD, BMJ, BMN	

Safe mat glass - in standard (not applicable to BMD)
Transparent glass - extra charge (not applicable to BMJ)
chipboard must be ordered if a porthole is to be applied

So - dimension on the internal side of the porthole

CROWNS

for the door frame: DIN SYSTEM "60", DIN SYSTEM "80", POL-SKONE SYSTEM, DIN DUO SYSTEM, DUO SYSTEM



Crown for the "60" - "90" single leaf (slab) door for one side (1 piece)

ECO TOP surface finish

Surface finishes: HIGH TOP, LAMISTONE CPL, SILKSTONE

Painted*

VENEERS GROUP A, GROUP B, GROUP C

EXTRA CHARGES

for the double leaf (slab) door crown "100", "110"

*environment-friendly acrylic paints, RAL and NCS colours (except metallic ones) - available at an extra charge according to the colour groups (p. 10)

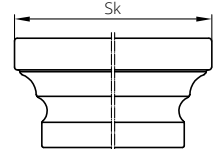

CROWN DIMENSIONS	for DIN door frame - Polish standard		for in-wall door housing - Polish standard		for the following door frames: ZN, ZT DIN SYSTEM, ZN DUO SYSTEM (not applicable to DIN DUO) - Polish standard		for the following door frames ZT SYSTEM POL-SKONE - Polish standard		for the following door frames ZT SYSTEM DIN DUO - Polish standard		for the following door frames ZY - Polish standard		for adjustable wooden door frame - Polish standard		for the following door frames DIN DUO (ZD) - Polish standard		for the following door frames ZZ (60mm Politrave) - Polish standard	
	60 mm wide architraves	80 mm wide architraves	60 mm wide architraves	80 mm wide architraves	60 mm wide architraves	80 mm wide architraves	60 mm wide architraves	for the following door frames ZT SYSTEM DIN DUO - Polish standard	for the following door frames ZY - Polish standard	hinge side D1-D16 range	adjustment side D13-D16 range	adjustment side D11-D12 range	for the following door frames DIN DUO (ZD) - Polish standard	hinge side ZZ1-ZZ17 range	adjustment side ZZ4-ZZ11 range	adjustment side ZZ1-ZZ3 range		
for single leaf (slab) door	total width of the door frame with a crown Sk (mm)																	
	type	823	863	802	842	823	863	874	869	913	913	903	869	875	865			
	"60"	923	963	902	942	923	963	974	969	1013	1013	1003	969	975	965			
	"70"	1023	1063	1002	1042	1023	1063	1074	1069	1113	1113	1103	1069	1075	1065			
	"80"	1123	1163	1102	1142	1123	1163	1174	1169	1213	1213	1203	1169	1175	1165			
	"90"	1133	1173	-	-	-	-	-	-	-	-	1238	1228	1194	1185	1175		
"90 PLUS"	1223	1263	1202	1242	1223	1263	1274	1269	1313	1313	1303	1269	1275	1265				
"100"	-	-	-	-	1323	1363	1374	1369	-	1413	1403	1369	1375	1365				
"110"	-	-	-	-	-	-	-	-	-	-	-	-	-	-	-			
for double leaf (slab) door	"60"+"60"	1457	1497	1393	1433	1456	1496	1508	1484	1540	1528	1518	1484	1510	1500			
	"70"+"60"	1557	1597	-	-	-	-	1608	1584	1640	1628	1618	1584	1610	1600			
	"70"+"70"	1657	1697	1593	1633	1656	1696	1708	1684	1740	1728	1718	1684	1710	1700			
	"80"+"60"	1657	1697	-	-	-	-	1708	1684	1740	1728	1718	1684	1710	1700			
	"80"+"70"	1757	1797	-	-	-	-	1808	1784	1840	1828	1818	1784	1810	1800			
	"90"+"60"	1757	1797	-	-	-	-	1808	1784	1840	1828	1818	1784	1810	1800			
	"80"+"80"	1857	1897	1793	1833	1856	1896	1908	1884	1940	1928	1918	1884	1910	1900			
	"90"+"80"	1857	1897	-	-	-	-	1908	1884	1940	1928	1918	1884	1910	1900			
	"90"+"90"	1957	1997	-	-	-	-	2008	1984	2040	2028	2018	1984	2010	2000			
	"90"+"90"	2057	2097	1993	2033	2056	2096	2108	2084	2140	2128	2118	2084	2110	2100			
	"90"+"100"	2157	2197	-	-	-	-	2208	2184	2240	2228	2218	2184	2210	2200			
"100"+"100"	2257	2197	-	-	2256	2296	2308	2284	2340	2328	2318	2284	2310	2300				
Hk (mm) - total height of the door frame with a crown																		
	2148	2148	2131	2131	2136	2136	2161	2156	2177	2177	2172	2156	2162	2157				

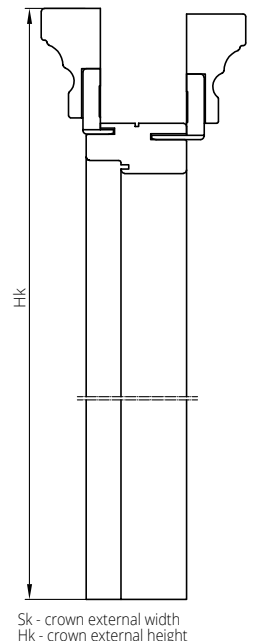

Sk - crown external width
Hk - crown external height

VENTILATION OPTIONS

	plastic tubes T1-T4, T10, T13-T15	plastic tubes T240-T243, T258, T260, T263, T276	plastic tubes T120, T258, T121, T132, T141, T276, T295	plastic tubes T293-T297	ventilation trim standard	ventilation trim SEMPRE	ventilation trim ARCO	ventilation trim FORTIMO / MONA	double ventilation slot	triple ventilation slot	plastic grill	stainless steel grill	bottom rail moisture protection*	NOTES
ARCO, SEDO, VERI, MODO, EGRO			X ²	X ²			X ¹							¹⁾ trim only with the "80" and "90" widths ²⁾ the "60" width comes with 3 tubes as a standard
INTER-AMBER	X		X		X				X		X	X	X	
IMPULS, NOSTRE, INVERNO, SONATA (W1, W2, W5, W7)	X	X		X	X				X		X	X	X	
SONATA (W4, W6)	X	X		X	X				X		X	X	X	¹⁾ ventilation grill only in the standard height version
IMPULS 13	X	X		X	X						X ¹	X ¹		¹⁾ ventilation grill only with the "70", "80" and "90" width models
ETIUDA A01, B1	X	X		X	X						X ¹	X ¹	X	¹⁾ only with the "70", "80" and "90" width models,
ETIUDA B0	X	X		X	X				X		X	X	X	
ESTATO B2, B3	X				X									
ETIUDA LUX A01, B1	X				X						X ¹	X ¹	X	¹⁾ only with the "70", "80" and "90" width models
ESTATO A01, B1														
CREATO A01														
ETIUDA LUX B0	X				X				X		X	X	X	
DECO	X	X		X	X				X		X	X	X	
INTERSOLID, INTERSOLID II	X				X						X ¹	X ¹	X	¹⁾ ventilation grill only in the standard height version
MODERN, MODENA	X				X				X		X ¹	X ¹	X	¹⁾ ventilation grill only in the standard height version
DECO LUX, CAMBIO, SIMPLE, TIARA (W01, W02, W05, W07), SUBLIME	X				X				X		X	X	X	
ESPIÑA	X				X				X ¹		X	X	X	¹⁾ not applicable to the W01 version
FIORD, TIARA (W03, W04, W06), VERTIGO, VILANO	X				X				X		X ¹	X ¹	X	¹⁾ ventilation grill only for the standard height
LUMEN					X									
PASSO					X									
FOLDING DUO	X	X	X	X										
SONATA LUX, SEMPRE LUX						X ¹					X ¹			¹⁾ only with the "80", "90" widths ²⁾ the "60" width comes with 3 tubes as a standard
SEMPRE		X ²				X ¹					X ¹			¹⁾ only with the "80", "90" widths ²⁾ the "60" width comes with 3 tubes as a standard ³⁾ not applicable to the W05, W07 version
FORTIMO		X ²		X ²				X ¹			X ¹			¹⁾ only with the "80", "90" widths ²⁾ the "60" width comes with 3 tubes as a standard
FORTIMO LUX								X ¹			X ¹			¹⁾ only with the "80", "90" widths ²⁾ the "60" width comes with 3 tubes as a standard
ESTATO LUX A01	X				X						X ¹	X ¹		¹⁾ only with the "70", "80" and "90" width models
HAPTIC					X				X		X	X	X	
TIARA W08	X			X	X									
SONATA W8														
MONA		X							X ¹		X ¹			¹⁾ trim only with the "80", "90" widths
ETIUDA, ETIUDA LUX, ESTATO, ESTATO LUX, CREATO (Versions A02, A03)					X ¹									¹⁾ only with the "70", "80" and "90" width models A02, A03
FIORI	X	X					X ¹							¹⁾ trim only with the "80" and "90" widths
LOFTY	X	X	X	X	X				X		X	X	X	

*not applicable to door leaves with a ventilation trim

The ventilation options for the DUO collection are to be applied as for the relevant door models

Door width	Door with ventilation trim			Door with ventilation tubes			Door with two rows of ventilation tubes		
	Total cross-section of ventilation holes with the 10 mm clearance maintained [m ²]	Total cross-section of ventilation holes with the 10 mm clearance maintained [m ²]	An additional clearance between door leaf (slab) lower edge and floor is required to fulfil requirements of the regulation* [mm]	Total cross-section of ventilation holes with the 10 mm clearance maintained [m ²]	Total cross-section of ventilation holes with the 10 mm clearance maintained [m ²]	An additional clearance between door leaf (slab) lower edge and floor is required to fulfil requirements of the regulation* [mm]	Total cross-section of ventilation holes with the 10 mm clearance maintained [m ²]	Total cross-section of ventilation holes with the 10 mm clearance maintained [m ²]	An additional clearance between door leaf (slab) lower edge and floor is required to fulfil requirements of the regulation* [mm]
REBATED	"60"	0.019	0.009	25**	0.011	20**	0.011	0.012	20**
	"70"	0.022	0.010	20**	0.012	15**	0.012	0.013	15**
	"80"	0.026	0.011	15**	0.013	10**	0.013	0.014	10**
	"90"	0.029	0.012	15**	0.014	10**	0.014	0.015	10**
	"100"	0.033	0.013	10**	0.015	10**	0.015	0.016	10**
DUO (NON-REBATED) REVES	"110"	0.036	0.014	10**	0.016	10**	0.016	0.011	20**
	"60"	0.016	0.009	25**	0.011	20**	0.011	0.012	15**
	"70"	0.020	0.010	20**	0.012	15**	0.012	0.013	15**
	"80"	0.024	0.011	15**	0.013	10**	0.013	0.014	10**
	"90"	0.028	0.012	15**	0.014	10**	0.014	0.015	10**
LUMEN	"100"	0.032	0.013	10**	0.015	10**	0.015	0.016	10**
	"110"	0.036	0.014	10**	0.016	10**	0.016	-	-
	"60"	0.015	-	-	-	-	-	-	-
	"70"	0.019	-	-	-	-	-	-	-
	"80"	0.023	-	-	-	-	-	-	-
ARCO	"90"	0.027	-	-	-	-	-	-	-
	"60"	0.017	-	-	-	-	-	-	-
	"70"	0.021	0.010	20**	-	-	-	-	-
	"80"	0.026	0.011	15**	-	-	-	-	-
	"90"	0.030	0.012	15**	-	-	-	-	-
SEMPRE	"100"	0.034	0.013	10**	-	-	-	-	-
	"60"	0.014	0.009	25**	-	-	-	-	-
	"70"	0.018	0.010	20**	-	-	-	-	-
	"80"	0.023	0.011	15**	-	-	-	-	-
	"90"	0.027	0.012	15**	-	-	-	-	-
FORTIMO	"100"	0.032	0.014	10**	-	-	-	-	-
	"60"	0.016	0.009	25**	-	-	-	-	-
	"70"	0.020	0.010	20**	-	-	-	-	-
	"80"	0.024	0.011	15**	-	-	-	-	-
	"90"	0.028	0.012	15**	-	-	-	-	-

The standard clearance between the door leaf (slab) and the floor is 10 mm.

* According to the Ordinance of the Minister of Infrastructure of 12 April 2002 on the technical conditions which must be fulfilled by buildings and their location. (Journal of Laws, 75 of 2002, item 690 as amended, Journal of Laws no 33 of 2003, item 270, Journal of Laws no 109 of 2004, item 1156), Chapter 6, §. 79. "A bathroom, washroom and separate toilet door should be openable outwards and have, subject to § 75 section 2, at least 0.8 m and a height of 2 m within the clear opening of the door frame and - in the lower part - air inlet holes with a total cross-section area not smaller than 0.022 m²".

** increase the clearance by the specific value by shortening the door leaf (slab) from the bottom side in case when shortening is possible. Self-shortening the door will void the warranty.

Door leaves unavailable for shortening:

- Etiuda, (Etiuda Lux) versions A1-A3
- Sempre version W05 VERSE

Sliding door leaves fulfil requirements of the regulation without the need to add a ventilation trim or ventilation tubes due to their structural design (approximate 20 mm offset from the wall/on-wall system). The ventilation grills and the stainless steel panels with ventilation surface fulfil requirements of the regulation.

VENTILATION OPTIONS

VENTILATION*

PANEL-BASED STRUCTURE

	A	B	C	D
"80"	844	704	525	825
"90"	944	804	625	925

ventilation trim in non-rebated doors in DUO collections - extra charge

ventilation trim - extra charge, veneered surfaces - extra charge, synthetic/painted surfaces

IMPULS W13

IMPULS W13 "80" door leaf (slab) with a ventilation trim - extra charge

IMPULS W13 "90" door leaf (slab) with a ventilation trim - extra charge

ARCO, SEDO

door leaf (slab) ARCO "80", SEDO "80" with a ventilation trim

door leaf (slab) ARCO "90", SEDO "90" with a ventilation trim

VERTIGO, VILANO

door leaf (slab) VERTIGO, VILANO "80" with a ventilation slot

door leaf (slab) VERTIGO, VILANO "90" with a ventilation slot

SEMPRE/SEMPRE DUO

door leaf (slab) SEMPRE "80" with a ventilation trim

door leaf (slab) SEMPRE "90" with a ventilation trim

door leaf (slab) SEMPRE "80" with a ventilation slot

door leaf (slab) SEMPRE "90" with a ventilation slot

ventilation slot in the SEMPRE, INTERSOLID collection leaves- extra charge

ESTATO, ESTADO LUX, CREATO, ETIUDA, ETIUDA LUX "80" (applicable to versions A01-A03)

rebated version

version A01

version A02

version A03

non-rebated version

version A01

version A02

version A03

ventilation trim - extra charge

The standard clearance between the door leaf (slab) and the floor is 10 mm.
 * According to the Ordinance of the Minister of Infrastructure of 12 April 2002 on the technical conditions which must be fulfilled by buildings and their location. (Journal of Laws, 75 of 2002, item 690 as amended, Journal of Laws no 33 of 2003, item 270, Journal of Laws no 109 of 2004, item 1156), Chapter 6, §. 79. "A bathroom, washroom and separate toilet door should be openable outwards and have, subject to § 75 section 2, at least 0.8 m and a height of 2 m within the clear opening of the door frame and - in the lower part - air inlet holes with a total cross-section area not smaller than 0.022 m²".
 ** increase the clearance by the specific value by shortening the door leaf (slab) from the bottom side in case when shortening is possible.
 Door leaves unavailable for shortening: ETIUDA (ETIUDA LUX) versions A1-A3; Sempre version W05 VERSE
 The sliding door leaves fulfill the requirements of the regulation without the need to add a ventilation trim or ventilation tubes due to their structural design (offset from wall/tunnel by about 20 mm).

VENTILATION OPTIONS

VENTILATION TUBES made of plastic (a set of 4 pcs)



VENTILATION TUBES made of plastic (a set of 4 pcs) - designed to match the door leaf (slab) colour

HIGH TOP



T292
coffee ash

ECO TOP



T121 oak T132 walnut T120/T258 white T161 half oak T141 Salinas oak T276 honey oak

LAMISTONE



T258 white T260 white oak T263 premium walnut T240 whitewashed elm T241 sand elm T242 grey elm T243 delano oak T250 terra oak T276 Polish oak

SILKSTONE

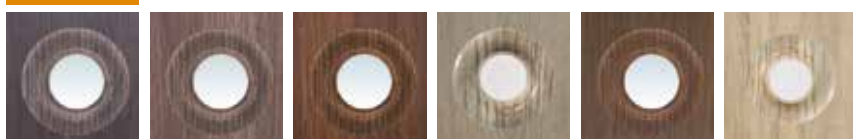

T293 Royal anthracite T294 Royal ash T295 Royal merbau T296 Polish ash T297 Royal nougat T230 gran oak

The actual colours may vary from the colours printed in this catalogue.

The ventilation tubes do not fulfil the requirements of the Ministerial regulation concerning the cumulative cross-section of the holes for air supply.

VENTILATION OPTIONS

PANEL WITH VENTILATION SURFACE



extra charge "70"
extra charge "80"
extra charge "90", "90 PLUS"
extra charge "100"
extra charge "110"

VENTILATION TUBES*

made of plastic



white



brown



black



beige



grey



anthracite

made of stainless steel



H17 clip fastening
acid resistant, clip fastening

Stainless steel grills and panels are optionally available on request.
The area of air inflow holes is more than 0.022 m².

* According to the Ordinance of the Minister of Infrastructure of 12 April 2002 on the technical conditions which must be fulfilled by buildings and their location. (Journal of Laws, 75 of 2002, item 690 as amended, Journal of Laws no 33 of 2003, item 270, Journal of Laws no 109 of 2004, item 1156), Chapter 6, §. 79. "A bathroom, washroom and separate toilet door should be openable outwards and have, subject to § 75 section 2, at least 0.8 m and a height of 2 m within the clear opening of the door frame and - in the lower part - air inlet holes with a total cross-section area not smaller than 0.022 m²".

STAINLESS STEEL 0.6 MM THICK PROTECTORS of leaf (slab) and door frame edges

The vertical leaf (slab) edge protectors can be used for the 40 mm thick leaf (slab) in the LAMISTONE, SILKSTONE, CPL 0.2, CPL 0.5, CPL 0.7 and VENEERED coating. The protectors are suitable only for hinges type T.

TYPE OF PROTECTOR

(vertical protector of the lock side and a vertical protector of the hinge side)

Complete set of the 40 mm thick leaf (slab) protectors

In case of swing doors, the leaf (slab) edge protector is installed on the side opposite to the hinge side.



ACCESSORIES

HINGES FOR INTERIOR DOORS

rebated system



screwed-in B type pivot hinge, silver zinc or brushed nickel

rebated system



screwed-in D type pivot hinge, silver zinc or brushed nickel

rebated system



screwed-in C* type pivot hinge, silver zinc or brushed nickel

rebated system



screwed-in K* type pivot hinge, silver zinc or brushed nickel

rebated system



M type pivot hinge, silver zinc, for the metal door frame

rebated system



hinge with closing function (wooden door frame, fixed or adjustable on one side), silver zinc

*hinges and door frame is a set. If you order to leaf (slab) door only, should order hinges.

rebated system



Three-part T* type hinge, silver, for the DIN SYSTEM door frame

rebated system



Three-part T* type hinge, black, for the DIN SYSTEM door frame

rebated system



Three-part T* type hinge, black, for the metal door frame

non-rebated system



HARMONY* adjustable concealed hinge, satin chrome

non-rebated system



HARMONY* adjustable concealed hinge, white

non-rebated system



HARMONY* adjustable concealed hinge, black (the BLACK collection)

non-rebated system



DUO* adjustable concealed hinge, satin nickel

non-rebated system



DUO* adjustable concealed hinge white

non-rebated system



DUO* adjustable concealed hinge, black (the BLACK collection)

non-rebated system



TE* adjustable concealed hinge, silver

non-rebated system



TE* adjustable concealed hinge, white

non-rebated system



TE* adjustable concealed hinge, black

LOCKS



rebated version



non-rebated version

NEW

HINGE CAPS, Type I (a set of 2 pcs per one hinge)



colours: golden, chrome, chrome-matt, patina, black
Type I caps are used for the C type and K type hinges. A single set of hinge caps consists of two identical caps.

HINGE CAPS, Type II (1 set per one hinge)

1 set - 2 pcs



colours: white, brown, golden, chrome, chrome-matt, patina, black

Type II caps are used for the B type and D type hinges. A set of caps per one hinge consists of a short cap (the upper part) and a long cap (the lower part).

ACCESSORIES

AUTOMATIC DOOR CLOSER GEZE TS 2000



closer
colours: silver, white, brown, black

Required reinforcement for automatic door closer and reinforcement under the door frame architrave. Other models of automatic door closers are available upon consultation with the Sales Department.



drop seal

Suitable only for a leaf (slab) with a min. thickness of 40 mm (lower rail and stile set).

HOOK LOCK for sliding doors



WK lock option

chrome, chrome-matt, golden, golden-matt, patina
black



WC lock option

chrome, chrome-matt, golden, golden-matt, patina
black

PULL HANDLES for sliding doors



U1 golden
U2 golden - matt
U3 chrome
U4 chrome - matt
U5 patina
U6 black

124 mm

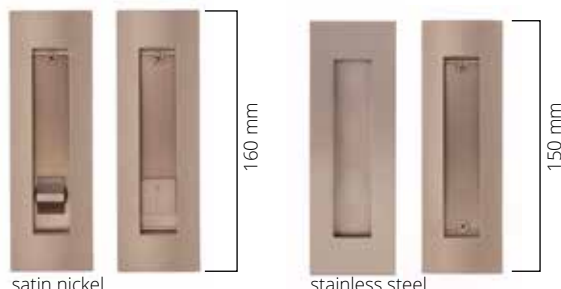

satin nickel stainless steel

160 mm

150 mm

ENTERO nickel satin for screws
ENTERO nickel satin for screws + WC hook lock
ENTERO II stainless steel + WC lock
ENTERO II stainless steel



satin nickel

Pull handle MAYA

satin nickel + key lock
satin nickel
satin nickel + hook lock for a cylinder
satin nickel + WC lock

189 mm

PULL HANDLES for folding doors (included in the door leaf (slab) price as a standard)

made of plastic



01 white
02 beige
03 brown
04 grey

ALUMINIUM DECORS (TIARA, SONATA)



chrome matt (standard)



golden gloss (option)



black (option)



chrome gloss (option)

HANDLES FOR INTERIOR DOORS

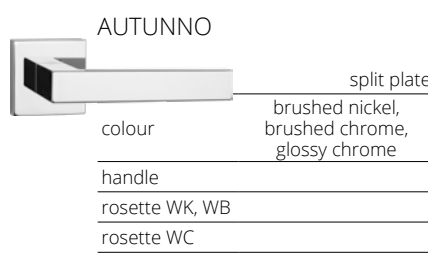
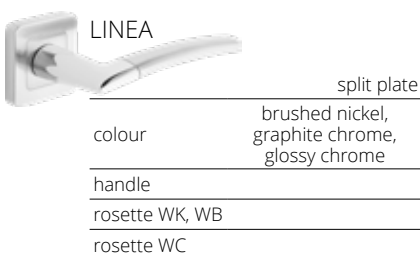
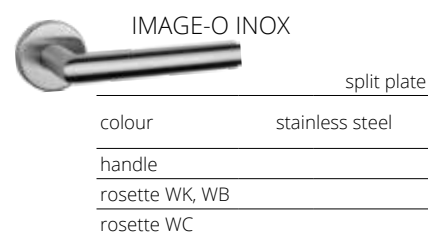
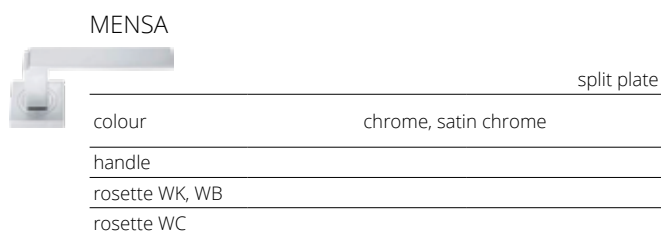
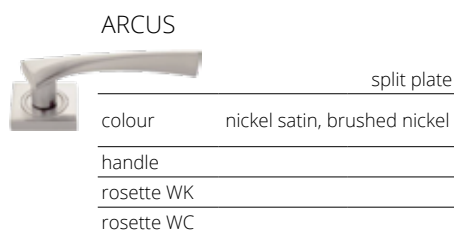

	SEMPRE		split plate
colour	nickel		
handle			
rosette WK, WB			
rosette WC			

	VERANO		split plate
colour	glossy chrome, brushed nickel, brushed chrome, black		
handle			
rosette WK, WB			
rosette WC			

	ESTATE		split plate
colour	brushed chrome, brushed nickel		glossy chrome
handle			
rosette WK			
rosette WC			

	ARABIS		split plate
colour	black		
handle			
rosette WK, WB			
rosette WC			

	IBIZA		split plate
colour	black		
handle			
rosette WK, WB			
rosette WC			

	TWIST		split plate
colour	stainless steel		
handle			
rosette WK, WB			
rosette WC			

	PRIMAVERA		split plate
colour	brushed chrome without insert, black without insert		
handle			
rosette WK			
rosette WC			
The insert in the colour of the door is available. Insert-compatible handle			

	INVERNO		split plate
colour	brushed nickel, brushed chrome, black		
handle			
rosette WK, WB			
rosette WC			

	APRILE		split plate
colour	glossy chrome, brushed nickel, brushed chrome		
handle			
rosette WK, WB			
rosette WC			

	LATON		split plate
colour	stainless steel		
handle			
rosette WK, WB			
rosette WC			

	NIQUEL		split plate
colour	stainless steel		
handle			
rosette WK, WB			
rosette WC			

	HALLEY		split plate
colour	chrome/brushed nickel, antique brass		
handle			
rosette WK, WB			
rosette WC			

	HIGRO		split plate
colour	stainless steel		
handle + rosette WK			
handle + rosette WB			
handle + rosette WC			
Handle + rosette HIGRO WC are designed for HIGRO doors only.			

	EXIMUS		split plate
colour	chrome/black, chrome/white, satin chrome/black, satin chrome/white		
handle			
rosette WK, WB			
rosette WC			

BERGENIA



split plate

colour	black matt, polished chrome, satin chrom, polished gold, gold matt
handle	
rosette WK, WB	
rosette WC	

LUPINA



split plate

colour	black matt, polished chrome, satin chrom
handle	
rosette WK, WB	
rosette WC	

ARNICA



split plate

colour	black matt, polished chrome, satin chrom
handle	
rosette WK, WB	
rosette WC	

PATINA



split plate

colour	stainless steel
handle	
rosette WK, WB	
rosette WC	

SATEN



split plate

colour	stainless steel
handle	
rosette WK, WB	
rosette WC	

ANMI



split plate

colour	golden-matt golden gloss
handle	
rosette WK, WB	
rosette WC	

GALE (left, right)



long plate spacing: 72 mm

colour	chrome, brushed nickel, antique brass
handle + rosette WK	
handle + rosette WB	
handle + rosette WC	

dedicated for doors in the rebated system

CYLINDERS FOR INTERIOR DOORS

30/35 LOB
30/30 LOB
30/40 LOB
35/30 LOB
26/26 WILKA

CYLINDERS

Lp.	Cylinder size	Manufacturer	Interior door								
			rebated single leaf (slab) type, Type A, Type B	rebated double leaf (slab) type	non-rebated single leaf (slab) type, Type A, Type B	non-rebated with an electric strike	non-rebated double leaf (slab) type	non-rebated double leaf (slab) Type A, Type B, HARMONY INVEST	Harmony, REVES	Lumen	STALIO
1	30x35	LOB	x	x			x				
2	30x30	LOB			x					x	
3	30x40	LOB						x			
4	35x30	LOB				x			x		
5	26x26	Wilka									x

GALIO
STALIO
LUMEN LOFT





Warszawa

POLAND

Lublin

 **POL-SKONE**[®]
DOORS AND WINDOWS

BUSINESS PARTNER

POL-SKONE Sp. z o.o.

ul. Hanki Ordonówny 8; 20-328 Lublin, Poland

tel.: +48 81 728 52 85; +48 81 744 30 11-13

fax: +48 81 744 24 89; +48 81 744 39 12

e-mail: pol-skone@pol-skone.eu

www.pol-skone.eu

This Product Catalogue is valid from 01.08.2023 (on this day, all earlier POL-SKONE catalogues become invalid).
The present publication does not constitute a commercial offer as defined under applicable laws and is provided for informative purposes only.
The manufacturer reserves right to introduce modifications.